

aumüller

Installation and Commissioning Instructions

Power supply according to EN12101-10 and Control Unit according to prEN12101-9



RWA - CONTROL UNIT EMB 8000+ (5A / 10A / 24A / 48A / 72A) CE



tested electrical control device EMB 8000+
with recognition number G512005

01	<p>Abbreviations Warning and Safety Symbols Target Groups, Intended Use Safety Instructions, Guidelines and Standards</p>	3 - 6
02	<p>Overview: EMB 8000+ in the installation Overview: EMB 8000+ module</p>	7 - 8
03	<p>Technical Data Preparing assembly Information regarding equipment and version of Control Unit Arrangement, order and connection of modules on standard rail</p>	9 - 13
04	<p>INSTALLATION STEP 1: Connection: Main power supply INSTALLATION STEP 2: Connection: Modules to BUS INSTALLATION STEP 3: Networking of Control Unit</p>	14 - 22
05	<p>INSTALLATION STEP 4: Connection: Power-Module-Extension PME and Power-Module PM INSTALLATION STEP 5: Connection: Control-Module CM INSTALLATION STEP 6: Connection: Sensor-Module SM INSTALLATION STEP 7: Connection: Drive-Module DM (10 A) / DMX (20 A) / IDM (10 A) INSTALLATION STEP 8: Connection: Relay-Module RM6 and Connection: IM-K INSTALLATION STEP 9: Connection: Weather-Module WM INSTALLATION STEP 10: Connection: BUS-smoke detector and BUS-break-glass units (HSE)</p>	23 - 45
06	<p>INSTALLATION STEP 11: Modify module configurations INSTALLATION STEP 12: Enabling operation / completing installation</p>	46
07	<p>Indicator and Control elements / Fuses Troubleshooting and repair Maintenance and Modification</p>	47 - 51
08	<p>Storage and Disposal Warranty and After-Sales Service Liability</p>	52

ABBREVIATIONS

Index of abbreviations	
These abbreviations are used consistently throughout this instruction. Unless stated differently, all dimensions indicated in this document are in mm. General tolerances in accordance with DIN ISO 2768-m.	
aP	Surface mounting
WxHxD	Width x Height x Depth
CAN	CAN-BUS
CM	Control-Module
COM	Common connection
DIN	German Institute for Standardisation
DM	Drive-Module
EN	European Standard
IN	Input
LON	Local Operating Network
OUT	Output
PG	Price group
PM	Power-Module
PS	Power supply
RM6	Relay-Module
RWA	Smoke and heat exhaust ventilation (SHEV)
SM	Sensor-Module
uP	Flash mounting
WM	Weather-Module
WRG	Wind direction sensor







Colour abbreviation according to IEC 60757					
BK	black	GY	grey	VT	violet
BN	brown	OG	orange	WH	white
BU	blue	PK	pink	YE	yellow
GN	green	RD	red		

Scale units	
°C	Degree Celsius
A	Amperes
Ah	Amp-hours
kg	Kilogram
m	Metres
min	Minutes
mm	Millimetres
s	Seconds
V	Volts
PU	Packaging Units
Vpp	Residual ripple (Voltage Peak-Peak)
W	Watts
Ω / k Ω	Ohm / Kiloohms

Figures	
AC	Alternating current (50Hz / 60Hz)
DC	Direct current
I	Electric current
L	Length
ME	Module space unit (1 ME = 23 mm)
NC	Contact „closed“ (normally closed)
NO	Contact „opened“ (normally opened)
P	Electric power
R	Electrical resistance
U	Electric voltage
Um	Change over switch

WARNING AND SAFETY SYMBOLS IN THESE INSTRUCTIONS:

The symbols used in the instructions shall be strictly observed and have the following meaning:

- 
DANGER Failure to comply with the warning notes results in irreversible injuries or death.
- 
WARNING Failure to comply with the warning notes can result in irreversible injuries or death.
- 
CAUTION Failure to comply with the warning notes can result in minor or moderate (reversible) injuries.
- 
NOTE Failure to comply with the warning notes can lead to damage to property.
- 
Useful note for an optimum installation.
- 
Note regarding the system configuration setting options via the „Alpha“ configuration software.



Caution / Warning
Danger due to electric current.



Attention / Warning
Risk of damage to / destruction of Control Unit, drives and / or windows.

TARGET GROUP

These instructions are intended for personnel trained in electrical engineering and skilled operators of systems for natural smoke ventilation (NRA / RWA) (natural smoke exhaust system / smoke and heat exhaust system) and natural ventilation via windows, who are knowledgeable of operating modes and remaining risks of the system.



This device is not intended for use by persons (including children) with physical, sensory or mental limitations or lacking experience and / or knowledge.

INTENDED USE

Area of application / Scope of application

This control device is intended for powering and controlling electromotive operated windows in facade and roof areas. **The prime task of this product**, in combination with the electric window, **is to evacuate hot smoke and combustion gases in case of fire** to save human lives and protect property. **Furthermore**, the electric window ensures **fresh air supplied for natural ventilation** of the building.

Intended use according to the Declaration of Conformity

The control device is intended for stationary installation and electrical connection as part of a building.

In accordance with the attached Declaration of Conformity the control device, in combination with electromotive drives from **AUMÜLLER**, is released for its proper use at a power-operated window:

- Application for natural ventilation
 - with an installation height of the drive and the bottom side of sash of at least 2,5 m above the floor, **or**
 - with an opening width at the HSK of the driven part of < 200 mm by a simultaneous speed of < 15 mm/s at the HSK in closing direction.
- Application as NRWA (natural smoke and heat exhaust ventilator(s) for ventilation without dual purpose for ventilation in accordance with EN12101-2.

By connecting the window drives with a control device and their operation the builder of the complete system becomes the manufacturer of the power-operated window! If necessary, it is required to perform a risk assessment of the complete system in accordance with the Machinery Directive 2006/42/EG when the utilization or operation of the control device or the connected window drives deviate from their intended use!

NOTE

We recommend using exclusively system components by **AUMÜLLER**, because their compatibility is carefully checked in the factory. **AUMÜLLER** shall not assume liability for the system-compatible functioning of third party components. Applications and connections other than explicitly described in these instructions require the express written consent of **AUMÜLLER**. Utilization of applications and components not expressly authorised by **AUMÜLLER** are considered as unintended use even if their perfect functioning is proven at commissioning (e.g. approval under building law).

NOTE

SAFETY INSTRUCTIONS



WARNING

It is important to follow these instructions for the safety of persons. These instructions must be kept in a safe place for the entire service life of the products.

Area of application

The control device must be used only for its intended purpose. For additional applications, consult the manufacturer or its authorised dealer.

Installation

These instructions are intended for expert and safety-conscious electricians and / or qualified personnel familiar with the electrical and mechanical installation of drives and control systems.

Mounting material

The required mounting material must be modified to fit the occurring load.

Routing cables and electrical connection

Electrical lines and connections may be routed or installed only by approved specialist contractors. Never operate drives, Control Units, operating elements and sensors at operating voltages and connections contrary to the specifications of the manufacturer.

The planning and calculation of the wiring system is the responsibility of the builder or its agent or the authorised builder and must be performed according to the statutory provisions.

NOTE

All relevant instructions must be observed for the installation, specifically:

- VDE 0100 Setting up high-voltage systems up to 1000 V
- VDE 0815 Wiring cables
- Specimen Guideline on Conduits German designation (MLAR).



The power line on-site must be secured separately and provided all poles separators. After opening of the system housing voltage carrying parts are exposed. The system must be separated from the power supply and accumulator voltage before each intervention in the Control Unit of the system.

The types of cable, cable lengths and cross-sections must be selected in accordance with the manufacturer's technical data. If necessary, the cable types must be coordinated with the competent local authorities and energy supply companies. Low-voltage lines (24 V DC) must be routed separate from the high-voltage lines. Flexible cables may not be flush-mounted. Freely suspended cables must be equipped with strain reliefs.



Cables must be laid such way that they cannot be sheared off, twisted or bent during operation. It is recommended to perform an insulation measurement of the system's line network and to document this.

Clamping points must be checked for tightness of threaded connections and cable ends. Access to junction boxes, clamping points and external drive control systems must be ensured for maintenance work.

Commissioning, operation and maintenance

After the installation and after each modification in the set up all functions must be checked with a trial run. After the installation of the system is completed the end-user must be introduced to all important operating steps. If necessary, he must be advised of all remaining risks / dangers.

The end-user must be instructed in intended use of the drives and, if necessary, the safety instructions. The end-user must be specifically instructed that no additional forces, except for the pressure and tension in the opening and closing direction of the casement, may be applied to the spindle, chain or lever of the drive.

NOTE

Post warning signs!



Before working on the system, it must be completely disconnected from the power supply and emergency power supply (e.g. accumulators) and secured against being switched on again accidentally. While working in the Control Unit the workplace must be secured to prevent unauthorised access. You must ensure that unauthorised personnel are unable to open the Control Unit.

The installation instructions of system components (smoke detector, natural smoke and heat exhaust ventilators, drives, etc.) are part of the documentation for the complete system and must be kept accessible for authorised qualified personnel, together with the installation and operating instructions, for the entire service life of the system.



WARNING

Check all functions of the system before releasing it for operation.

Software terms and conditions

The Control Unit is configured by the factory for the intended use (standard configuration). The software, especially developed for this Control Unit, allows a quick and easy adjustment of the factory setting to the respective requirements. Furthermore, the system status can be saved, retrieved and printed.



Modifiable standard configurations are particularly emphasized in these instructions. The functional range of the unlicensed version can be expanded by activation against payment (license).

The prerequisites of the system (see chapter "SYSTEMS CONFIGURATION OF SOFTWARE") must be checked prior to installation. The "Software clause for handing over the standard software as part of shipments" of the ZVEI (German Electrical and Electronic Manufacturer's Association) is accepted as legally binding upon installation. See our homepage:

AUMÜLLER AUMATIC GMBH.
(www.aumueller-gmbh.de)



The configuration software of the control device largely excludes damage caused by incorrect settings. As a precaution, we advise that AUMÜLLER, as manufacturer, cannot assume liability for damage caused by using AUMÜLLER software, because AUMÜLLER has no influence on a perfect system environment or property-specific systems configuration.



We, therefore, recommend protecting the operating system and system software sufficiently against unauthorised interference (e.g. by using a password) and attending the training provided by the manufacturer.

Replacement parts

System components are to be replaced only with spare parts from the same manufacturer. Liability, warranty and customer service are void if third-party parts are used. Only original spare parts from the manufacturer are to be used for expansions.

Ambient conditions

The product may not be subjected to impacts or falls, or to vibrations, moisture, aggressive vapours or other harmful environments, unless the manufacturer has released it for one or more of these environmental conditions.

- **Operation:**
 - Ambient temperature: -5 °C ... +40°C
 - Relative humidity: < 90% up to 20°C;
< 50% up to 40°C;
no formation of condensation
- **Transport / Storage:**
 - Storage temperature: 0°C ... +30°C
 - Relative humidity: < 60%

Accident prevention regulations and employer's liability insurance guidelines

For work on or in a building or building part the provisions and instructions of the respective accident prevention regulations (UVV and employer's liability insurance guidelines (BGR /ASR) must be observed and obeyed.

Declaration of Conformity

The control device is manufactured and inspected for its intended use in accordance with the European guidelines. The relevant Declaration of Conformity is at hand. If the use or operation of the control device or the connected window drives deviate from this a risk assessment must be performed for the complete powered window system and a Declaration of Conformity according to Machinery Directive 2006/42/EG issued as well as a CE labeling obtained.

GUIDELINES AND STANDARDS

It is essential that the most recent versions of country-specific laws, regulations, provisions and standards be observed during installation and for electrical connections.

These are for instance:

State building code with special construction regulations such as:

- Industrial construction guideline
- Venue regulations, etc.

MLAR - Sample Guideline on Conduits German designation

Provisions of the fire protection authorities TAB (technical connection conditions)

for Utility companies

German Regulations for Occupational Insurance Schemes, such as:

- ASR A1.6 and 1.7 (substitute for BGR 232)

Additional standards and guidelines, such as:

EN 60335-2-103 Safety of household and similar electrical appliances

EN 60730-1 Automatic electrical controls

EN 12101-10 / prEN 12101-9 (ISO 21927-9/10)

Smoke and heat control systems

DIN 4102-12 Functional integrity of electric cable systems

VDE 0100 Installation of high-voltage systems up to 1000 V

VDE 0298 Use of cables

VDE 0815 Wiring cables (for telecommunication and data processing systems)

VDE 0833 Alarm systems

VdS-Guidelines: 2593, 2581, 2580, 2592

Accident prevention regulations, in particular:

- VBG 1 „General rules“ and
- VBG 4 „Electrical systems and equipment“.

For placing on the market, installation and operation outside Germany, the relevant national laws, regulations, standards and safety provisions apply.

The contractor is responsible for proper installation or operation and the issue of a Declaration of Conformity according to European guidelines.

OVERVIEW: EMB 8000+

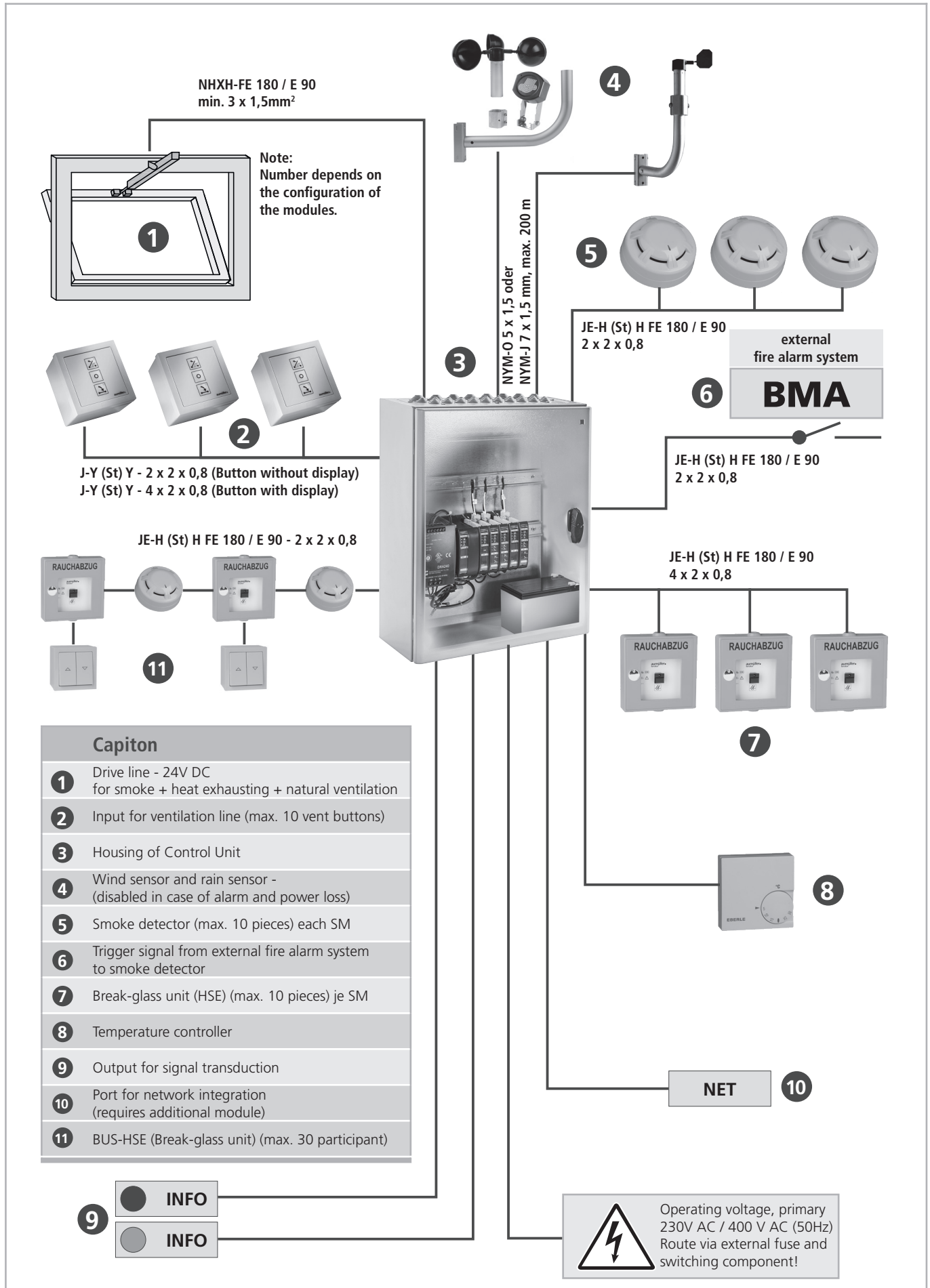

Capiton	
1	Drive line - 24V DC for smoke + heat exhausting + natural ventilation
2	Input for ventilation line (max. 10 vent buttons)
3	Housing of Control Unit
4	Wind sensor and rain sensor - (disabled in case of alarm and power loss)
5	Smoke detector (max. 10 pieces) each SM
6	Trigger signal from external fire alarm system to smoke detector
7	Break-glass unit (HSE) (max. 10 pieces) je SM
8	Temperature controller
9	Output for signal transduction
10	Port for network integration (requires additional module)
11	BUS-HSE (Break-glass unit) (max. 30 participant)

- 9** ● INFO
- INFO

 Operating voltage, primary 230V AC / 400 V AC (50Hz)
Route via external fuse and switching component!

OVERVIEW: EMB 8000+ MODULE

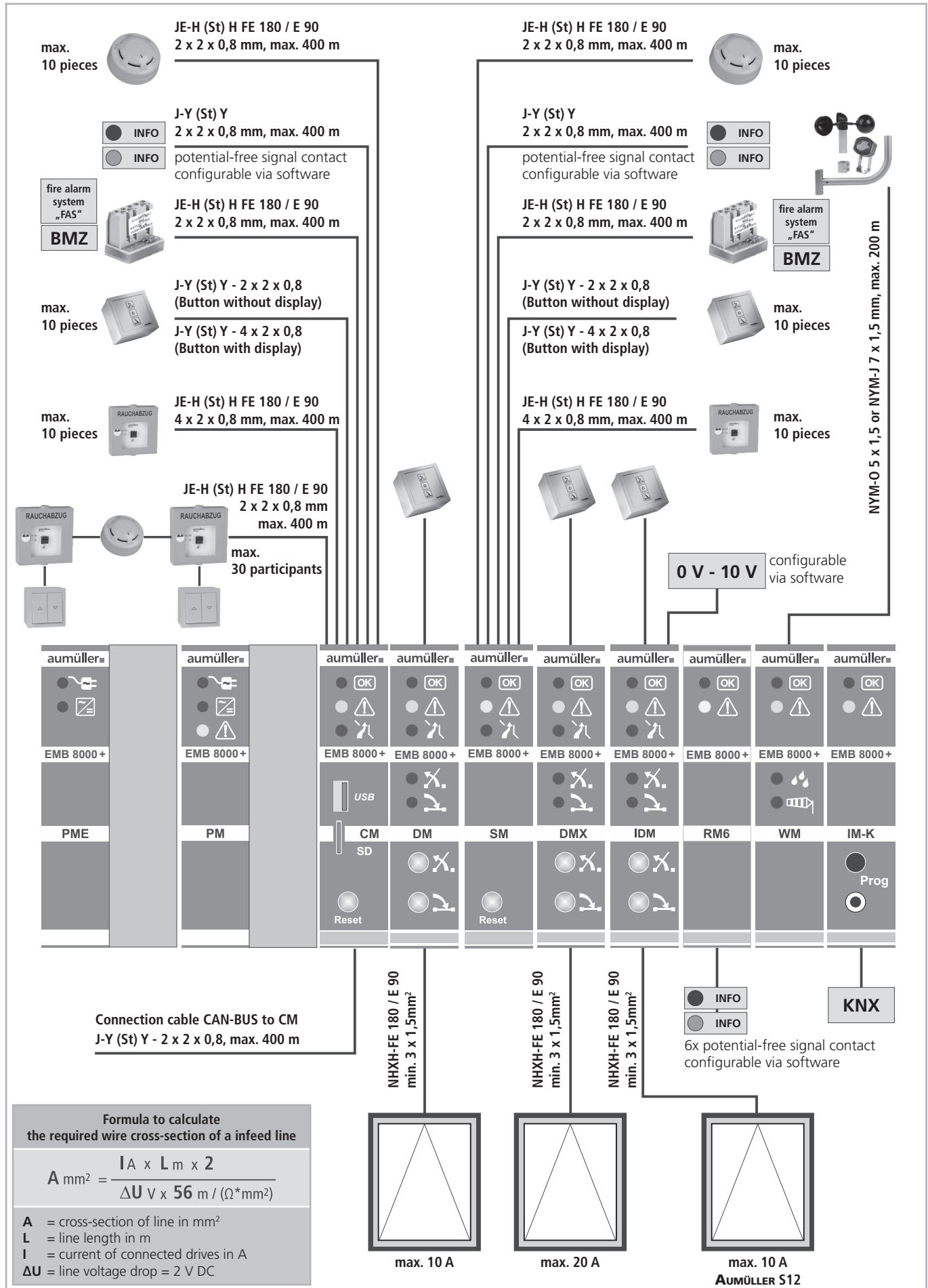

02

TECHNICAL DATA

Electrical data and connected loads	
Operating voltage, primary:	195...253 V AC
Frequency:	50...60 Hz
Current consumption (primary):	(depending on version)
Output voltage of switching power supply:	26V DC
Output voltage, drives:	24V DC nominal (19,3...28 V DC)
Residual drive voltage ripple:	< 1V
Switching consumption of drive lines:	per Drive-Module DM: max. 10 A per Drive-Module DMX: max. 20 A per Drive-Module IDM: max. 10 A
Emergency power supply:	max. 72 hours
Back-up accumulator voltage (charging voltage is temperature-compensated):	2 x 12 V
Nominal capacity:	depending on version
Nominal current (during short time operation):	
switching power supply 10 A	10 A
switching power supply 20 A	20 A / 24 A for 3 minute
Continuous current consumption:	approx. 30 % of nominal current
Automatic detectors per signalling line (term. 1/22, 1/23):	max. 10 pieces
Manual detectors per signalling line (term. 1-19):	max. 10 pieces
BUS detector each CM	max. 30 pieces
Automatic detectors per Control Unit:	max. 60 pieces
Manual detectors per Control Unit:	max. 60 pieces
Detector voltage:	≥ 18,2 V

Environmental Conditions (operation)	
Ambient temperature range:	-5...+40 °C
Maximum relative air humidity:	(according to EN 12101 Class 1) 75 % (mean value over lifetime) 90 % (for max. 96 hours)
Mechanical Data	
Surface mounted housing:	steel plate painted in RAL 7035 with locking mechanism (safety cylinder insert, 3 mm)
Protection class:	IP 40 (tested) IP 54 (not tested) with wall mounting brackets and seal.
Housing dimensions:	dependent on features of Control Unit



An EMERGENCY During OPEN, the drives are activated every 2 minutes within a period of 30 minutes (in accordance with VdS 2580).

The available internal emergency power supply (back-up accumulators), if correctly rated and serviced at regular intervals, ensures that the controller of the Control Unit opens the connected drives at least twice and closes them at least once after 72 hours of mains power supply loss.

PREPARING ASSEMBLY



Important instructions for safe assembly: Fully observe all instructions, incorrect assembly may lead to serious injuries.

Installation steps:

- 1.) Mount the housing on the wall in such a manner, that it is permanently secured and the Control Unit at the same time easily accessible for maintenance.
- 2.) Mount all drives and control elements. Adhere to specifications given in the drive assembly instructions and observe the allowable connection values.
- 3.) Feed all lines through the cable glands into the Control Unit and connect same.

On request, the manufacturer can issue the Control Unit circuit diagram.

Before starting the installation please check with the delivery note that the delivery is complete and correct, any complaints received later cannot be considered. It is required to keep a logbook for the **EMB 8000+** which must be accessible to authorised staff at all times.

Scope of delivery: RWA - Control Unit EMB 8000+

- Installation and Commissioning Instructions (german and english)
- Test report according to VDE 0113
- Label „Smoke Vent“
- „Maintenance instructions“ stickers
- Key

EXPANSION LIMITATION / SYSTEM LIMITS

The following key data must be taken into account when dimensioning RWA Control Units:

- Number of smoke detector per CM / SM 20 pieces
- Number of Break-glass unit (HSE) per CM / SM 10 pieces
- Number of digital Trigger-unit per CM 30 pieces
- Number of smoke detector per Control Unit 60 pieces
- Number of Break-glass unit (HSE) per Control Unit 60 pieces
- Own power consumption per Control Unit (see table on the next page)
- Accumulator capacity / max. Power consumption per Control Unit (see table on the next page)
- Housing size
- Cable entries

All values in the tables refer to the maximum assignment of the module inputs / outputs. The current values are given for maintaining the emergency power supply over a period of 72 hours. Other calculation bases on request.

The sum of the self-consumption of all modules in a Control Unit must not exceed the maximum permissible current of the Control Unit. To calculate the total power consumption, the individual consumption of the installed modules must be added.

The details of the outer diameter of cables refer to the cable types common in Germany. The wire cross-sections are given in mm². To maintain the electrical protection class of the Control Unit housing, only one cable is permitted per cable entry.

For checking purposes, the total number of cables required must be determined in accordance with Table 1 and coordinated with the number of cable entries in the Control Units from Table 4.

Due to the hardware and software, the EMB 8000+ is limited by the following points. Configuration using the software is guaranteed within these limits.

1. A maximum of 50 modules per Control Unit (including CM, excluding PM and PMEs).

The following maximum number of modules of the same type are supported per Control Unit (in the composite).

Module	Maximum per Control Unit	Maximum per composite
PME	2	60
PM	1	30
CM+	1	30
SM	20	570
DM	40	570
DMX	10	300
IDM	30	300
230V DM Vent	20	570
RM6	20	570
WM	1	2
IMK	2	5

2. A maximum of 30 Control Unit in the composite.

3. A maximum of 600 modules in a composite (including CMs, excluding PMs and PMEs) e.g. ∴ 30 Control Units with 20 modules or 12 Control Units with 50 modules.

4. 150 Can actuators (*) are supported at the same time without blocking the triggering CM. Each additional CAN actuator results in a recording delay of 9 ms.

(*) CAN actuator is an actuator in a different Control Unit than the one in which the sensor is located.

03

NOTES ON THE CONTROL UNIT EQUIPMENT AND VERSION

Determining the right equipment for the Control Unit

In order to be able to determine the right version and equipment of the Control Unit without a problem, the following procedure is recommended:

How high is the maximum required drive current?

The maximum drive current determines the number of switching power supplies as well as the number of Power-Module-Extensions **PME**. One Power-Module **PM** or a single **PME** can provide a maximum of **24 A** each via connected power supplies.

Important criteria for selection of back-up accumulators for the emergency power supply are:

- the maximum drive current
- the number and types of modules
- the number and types of connected detector



Because of the intrinsic power consumption of the modules, their allowable number depends on the version of the Control Unit.

In selecting the back-up accumulators, the bridging time for emergency power operation during a power failure must be taken into account.

How many ventilation groups are to be connected?

The Drive-Module **DM** enables a maximum current consumption of **10 A** for one ventilation group (**DMX** max. **20 A**).

How many ventilation groups are to be connected?

The Control-Module **CM** (first fire compartment) is required once in any case. Each additional fire compartment requires one Sensor-Module **SM**. A maximum of 10 detectors may be connected to one signalling line.

Is there a control required for ventilation via wind and rain sensors or a wind direction-dependent opening and closing in case of fire?

If so, a Weather-Module **WM** is required.

Should several Control Units be switched as a system unit via CAN-BUS?

If so, adhere to the instructions for installation and commissioning of the module. Configuration requires the licensed system software of the manufacturer.

NOTE

The housing size is determined by the number of modules and their arrangement, the number of required switching power supplies and the size of the back-up accumulators. Furthermore, attention must be paid to the required cable feedthroughs within the Control Unit housing, the number of which is dependent on the size of the housing.



Note that the back-up accumulator type and any Power-Module-Extension(s) **PME** used be configured via the system software.



Use only back-up accumulators with VdS approval!

Calculating: maximum allowable number of modules

In order to guarantee a high degree of adaptability to the variety of structural requirements, the **EMB 8000+** is designed as a modular RWA and ventilation system with regard to its digital **BUS** system as well as its hardware. This is how fire compartments as well as their furnishing with ventilation and drive lines can be optimally adapted to particular requirements with use of the relevant modules.

However, the number of modules per Control Unit is limited by the safety requirements outlined in EN 12101-10 with regard to capacity and emergency power supply. In case of fire, the system must also function reliably during a power failure and guarantee smoke and heat ventilation. Because the modules themselves have their own current consumption (with the exception of the Power-Module-Extension **PME**), their number is therefore dependent on the version of the control unit and the backup accumulators used for the emergency power supply.

The maximum allowable number of modules can be easily determined by using the tables below. Only the intrinsic consumption by the modules must be added. The sum may not exceed the allowable value.

If this should be the case, either the number of modules must be reduced or a Control Unit with a higher output selected.

NOTE

Intrinsic module consumption with back-up accumulator voltage 24 V

Power-Module	PM	=	16,0 mA
PM-Extension	PME	=	0,0 mA
Control-Module	CM+	=	34,1 mA
Sensor-Module	SM	=	12,6 mA
Drive-Modul	DM	=	5,3 mA
230 V-Drive-Module Vent	230V DM	=	7,0 mA
Drive-Module	DMX	=	5,3 mA
Drive-Module	IDM	=	6,0 mA
Relay-Modul	RM6	=	5,3 mA
KNX-Module	IM-K	=	6,0 mA
Weather-Module	WM	=	13,0 mA

Intrinsic consumption of backup accumulator powered detectors

Break-glass main unit	HSE	=	1,2 mA
Break-glass secondary unit	HSE-N	=	0,0 mA
Optical smoke detector	ORM	=	0,1 mA
Wind direction sensor	WRG	=	7,1 mA
BUS Break-glass unit	BUS-HSE	=	2,8 mA
BUS Smoke detector	BUS-RM	=	1,0 mA

Maximum allowable intrinsic current consumption of all Control Unit modules

Switching power supply / backup accumulator	7 AH	12 AH	17 AH	24 AH	38 AH
10 A	42 mA	120 mA	140 mA	240 mA	350 mA
24 A		70 mA	120 mA	200 mA	300 mA
48 A			80 mA	170 mA	300 mA
72 A				100 mA	300 mA

Following module requirement as an example

PE	PME	CM	DM	DM	SM	DM	DM	SM	DMX	WM
16,1 mA	0,0 mA	34,0 mA	5,3 mA	5,3 mA	12,6 mA	5,3 mA	5,3 mA	12,6 mA	5,3 mA	13,0 mA

The modules' total own current consumption amounts to 107,4 mA. The appropriate versions of the respective Control Unit can be determined from the top table.

If the Drive-Modules are utilized with their maximum current consumption as in the example above, there will be a total drive current requirement of **60 A** (4 x **DM** plus 1 x **DMX**).

The appropriate Control Unit would be in this case the **EMB 8000+ / 72 A** with 2 x 38 Ah.

The **EMB 8000+ / 72 A** with 2 x 24 Ah would be underdimensioned because of its modules' intrinsic consumption of 107,4 mA!

Space requirement for modules

Once the required number of modules is determined, their space requirement on the standard rail can be easily calculated with the respective module width:

Space requirement for modules

2 ME / approx. 46 mm		1 ME / approx. 23 mm	
Power-Module	PM	Control-Module	CM
Power-Module-Extension	PME	Sensor-Module	SM
Drive-Module	DMX	Drive-Module	DM / IDM
		230V-Drive-Module Vent	230V DM
		Relay-Module	RM6
		KNX-Module	IM-K
		Weather-Module	WM

Main functions of the modules:

- The Power-Module **PM** provides - depending on the switching power supply - **5 A, 10 A** or **24 A**.
- One Power-Module-Extension **PME** provides an additional **24 A**.
- The Control-Module **CM** or Sensor-Module **SM** have at their disposal three signalling lines with a max. of 10 detectors in each case per signalling line and an option to connect ventilation controls.

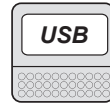

The difference between the Control-Module **CM** and the Sensor-Module **SM** is that the Control-Module **CM** must be employed only once and obligatorily for the first fire compartment. The **CM** has in addition a **USB** port and its ventilation control commands are by default superior to all ventilation groups (joint closing).

- The Drive-Module **DM** has at its disposal one drive line with up to max. **10 A** (**DMX** max. **20 A**) switching current. The triggering of gas pressure generators or magnetic clamps is possible with appropriate software configuration. The connection of ventilation controls and operational status displays is intended.
- The Weather-Module **WM** for connection of wind and rain sensors and / or wind direction finders is required only once (normally).

03

ARRANGEMENT, ORDER AND CONNECTION OF MODULES ON THE STANDARD RAIL

Arrangement and order of modules

The modules are mounted on the standard rail directly next to each other.

Following module arrangement must be absolutely adhered to:

- The Power-Module **PM** and the Power-Module-Extension **PME** must be mounted to the extreme left and as the first element on the standard rail. Concurrently, the Power-Module-Extensions **PME** are always placed to the left of Power-Module **PM**.
- The Power-Module **PM** is followed to the right by the Control-Module **CM** (which is normally followed by one Drive-Module **DM** or **DMX** or **IDM**).

Connection of modules

When connecting the modules, one must differentiate between three kinds of connections:

Connection to the main power supply of

- Power-Module **PM**,
- Power-Module-Extension **PME**,
- Drive-Module **DM** / **DMX** / **IDM**

All modules with connection to the main power supply are secured with fuses. **BUS** connection (ribbon cable) of all modules on the bottom of the module, with the exception of the Power-Module-Extension **PME**. The communication between **PME** and **PM** is made via ribbon connection on top of the module.

If the modules are arranged on several standard rails, a special **BUS** cable (particular length) must connect the **BUS** on the lower standard rail with that on the upper standard rail.

Connection of external components (detectors, drives, etc.) via plug terminals on top of the module.

Arrangement / order of modules on standard rail

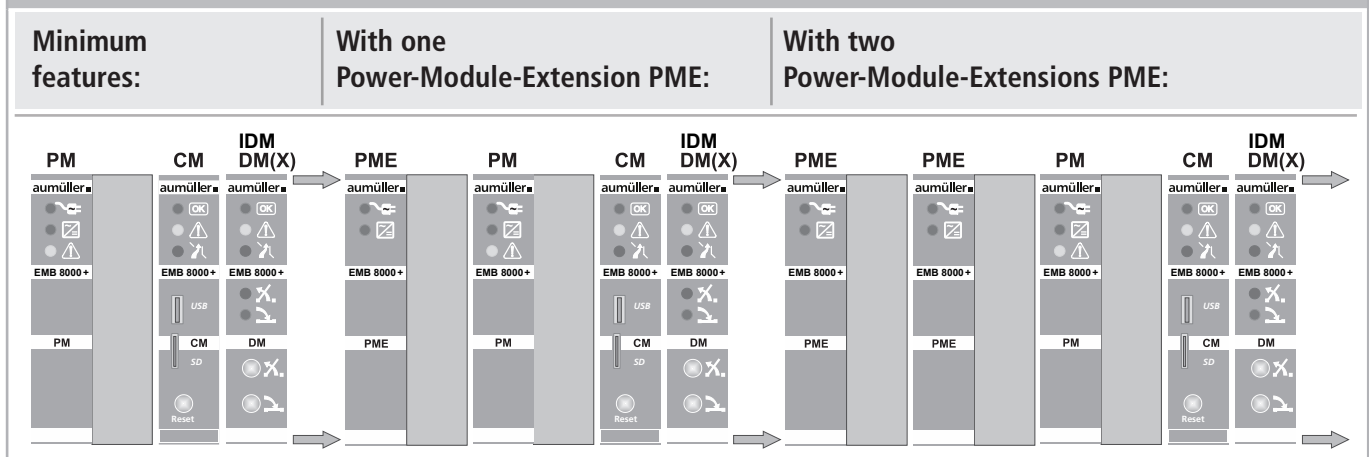

Arrangement of modules on standard rail - subdivided into fire compartments

Any further module arrangement is application-dependent. For reasons of clarity, it can be subdivided into fire compartments (Control-Module **CM** followed by Sensor-Module **SM** with the required number of ventilation groups (= Drive-Modules **DM** / **DMX** / **IDM**)). If a Weather-Module **WM** is used, it should round off the order of the modules.

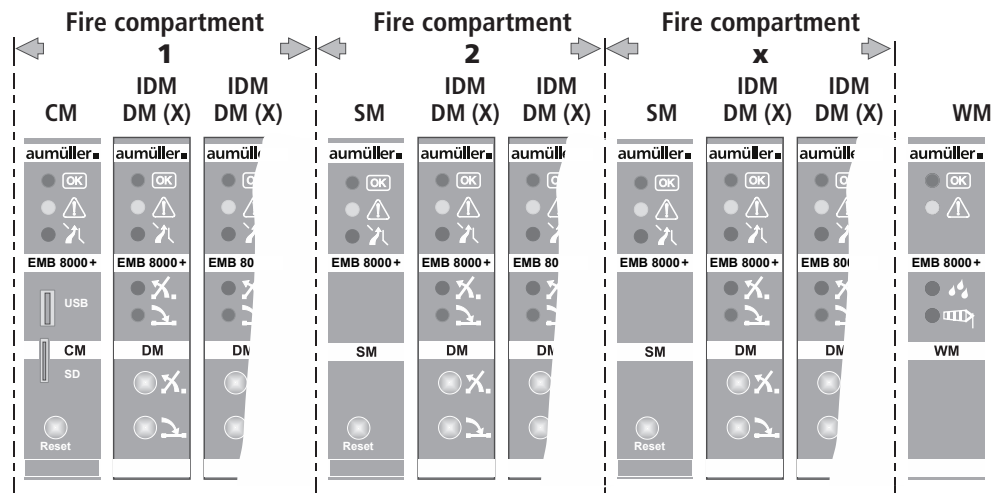

INSTALLATION STEP 1:
CONNECTION: MAIN POWER SUPPLY



Only connect when disconnected from the mains power supply! Switch off power supply and secure against reconnection! Disconnect accumulators!

If this has not been done already in the factory, all connections for the internal power supply and back-up accumulators must be made. This includes connection of the switching power supplies to Power-Module PM and if need be PME as well as placement of the back-up accumulators within the Control Unit housing and its connection. In addition, all Drive-Modules DM / DMX / IDM must be connected to the main power supply. No other modules require a connection to the main power supply.



The max. power consumption per Drive-Modules DM / DMX / IDM, which can be connected to a switching power supply with PM or PME depends on the respective switching power supply (5 A, 10 A, 24 A).

- e.g. Switching power supply 10 A with one DM with max. 10 A current consumption. Possible, however, are if need be also two DM with two ventilation groups with a maximum current consumption of only 5 A.
- e.g. Switching power supply 24 A for two DM with max. 10 A current consumption each. If need be, however, four DM, in as far as the maximum current consumption doesn't exceed 10 A per DM and 24 A total (analogously this applies to Drive-Module DMX).

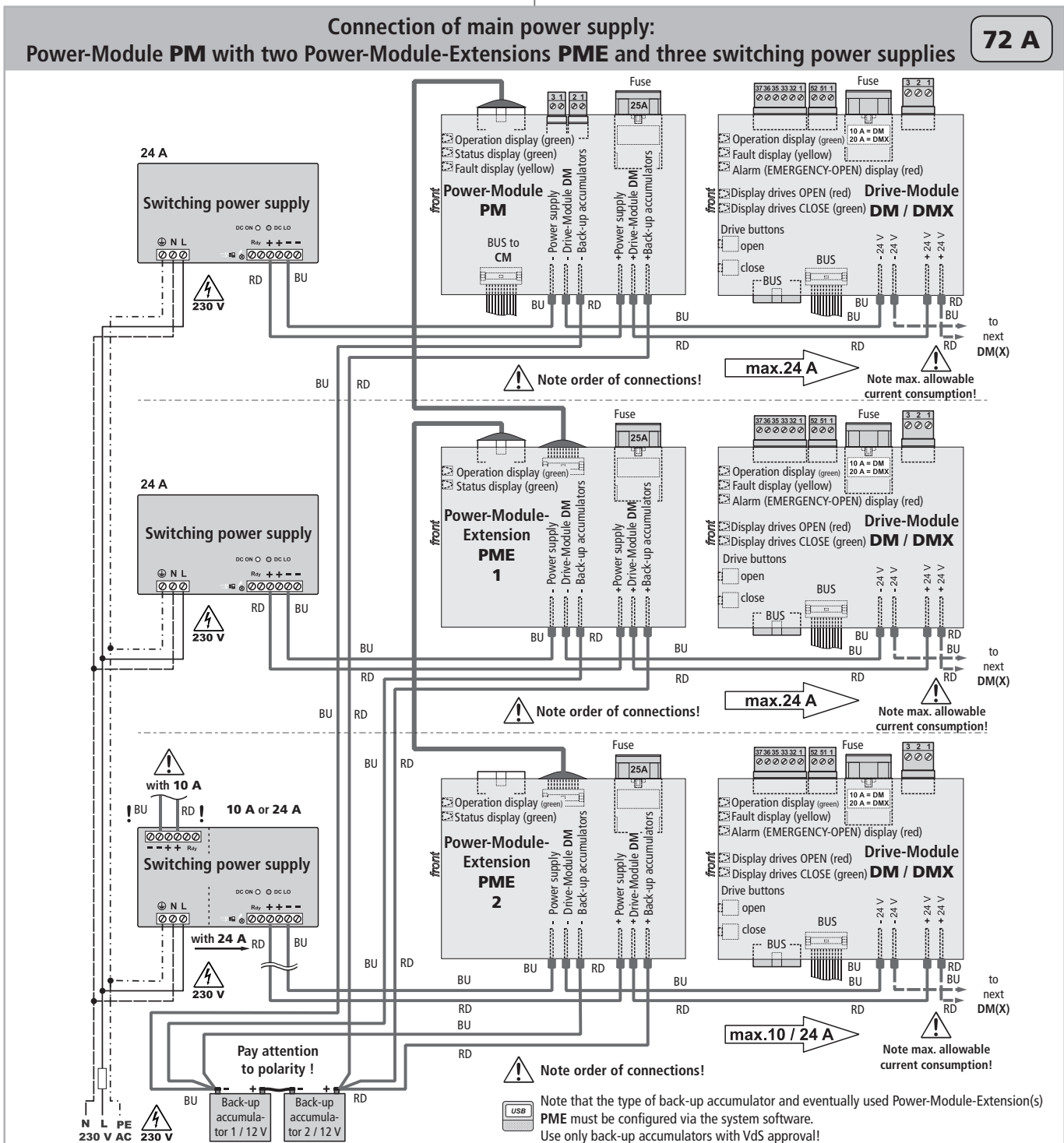

Note that the type of back-up accumulator and eventually used Power-Module-Extension(s) PME must be configured via the system software. Use only back-up accumulators with VdS approval!

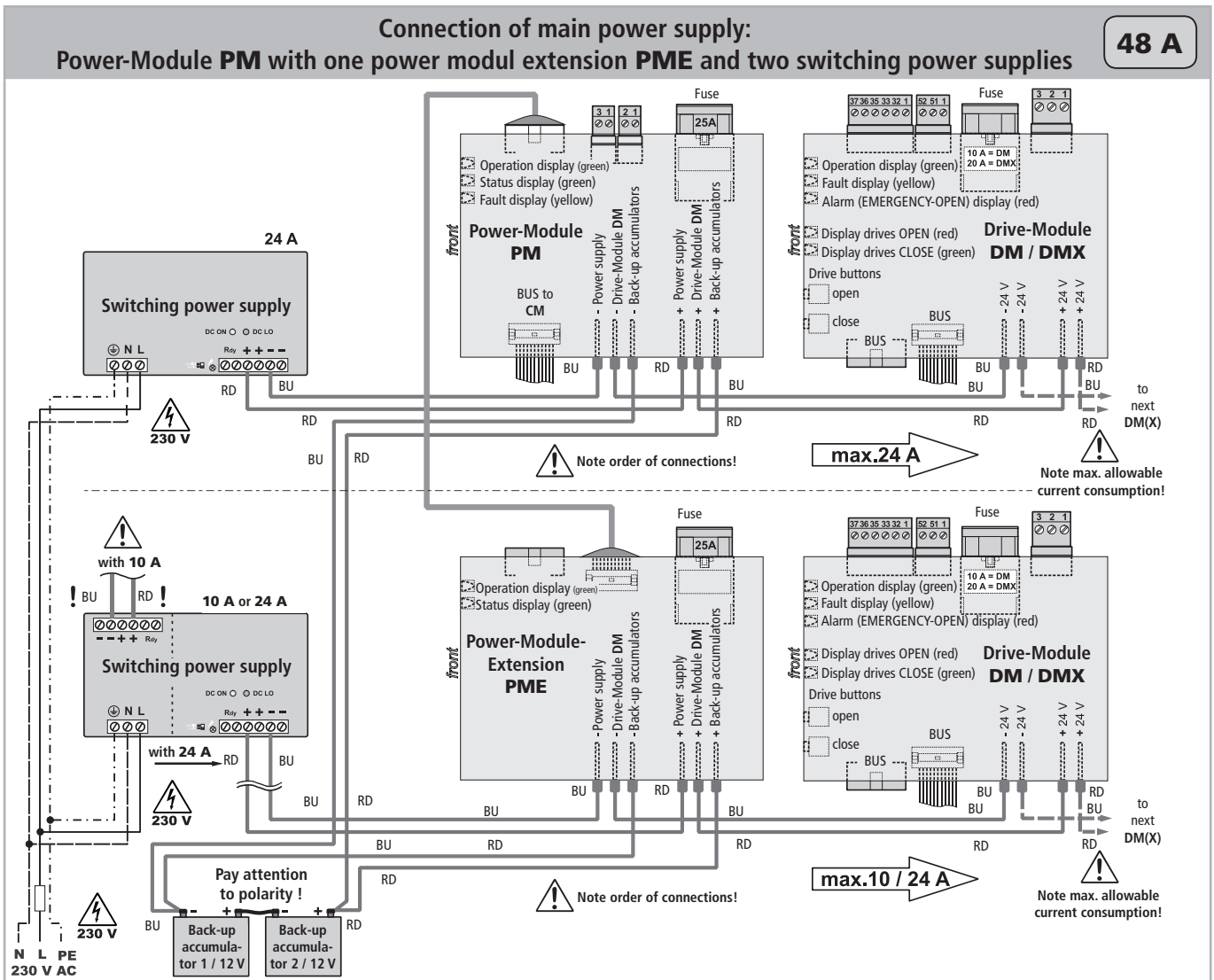
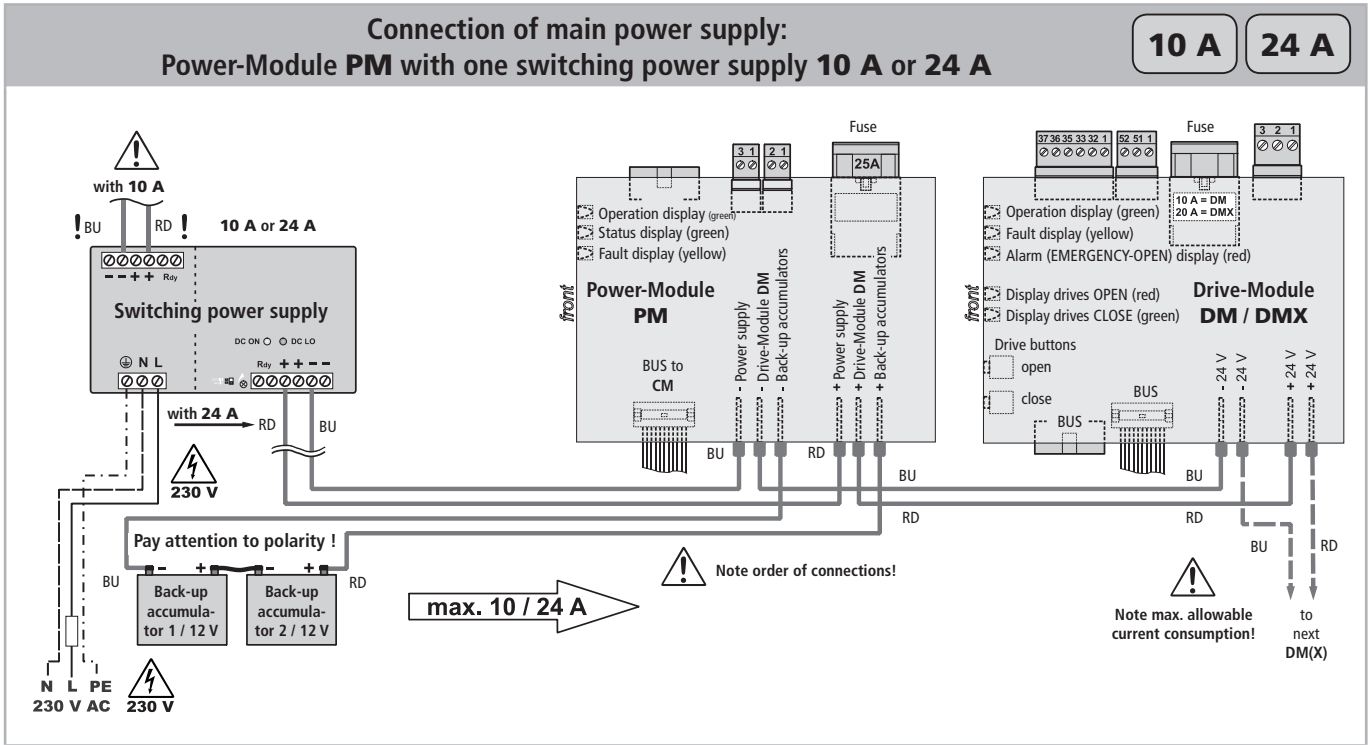

INSTALLATION STEP 2:
CONNECTION: MODULES TO BUS

Since we are dealing with a digital **BUS**, the modules can be interconnected with the ribbon cable on the bottom of the module independent of their function within the system.
The only exception is the Module-Extension **PME**. Its connection with the Power-Module **PM** is made with the narrow ribbon cable on the top of the module.



Only connect when **disconnected from the mains power supply!** Switch off power supply and secure against reconnection! Disconnect accumulators!
After switching off the power supply and disconnecting the batteries, it is necessary to wait at least 20 seconds before modules can be plugged in or unplugged.

BUS connection at the bottom

Connect modules from **PM** only diagonally at the bottom (to the right):

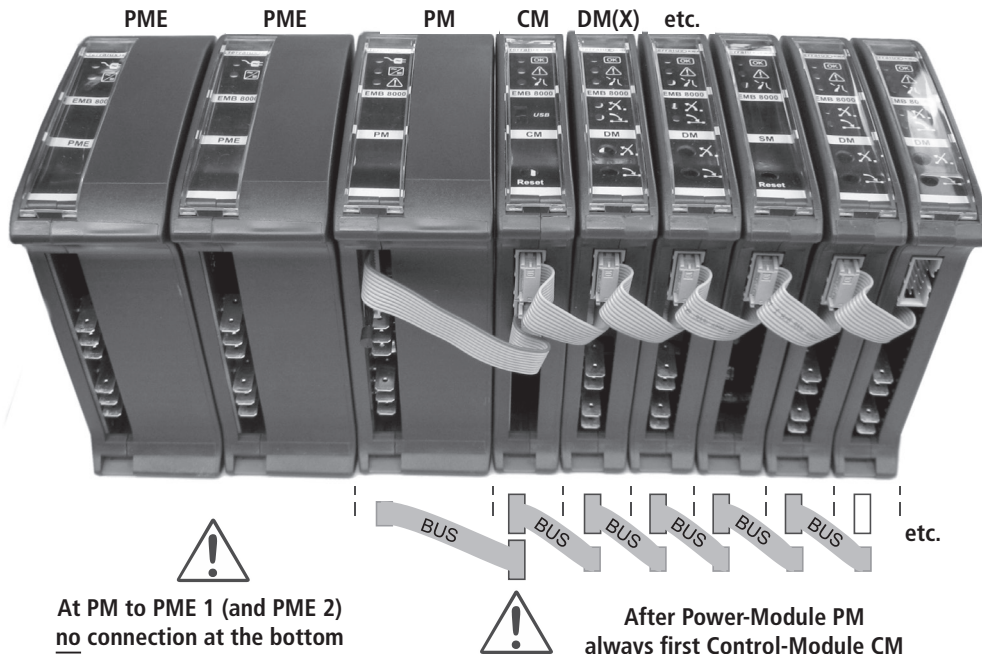

BUS connection at the top PME - PME - PM

Connect diagonally at the top only **PM** with **PME 1** (and **PME 2**):

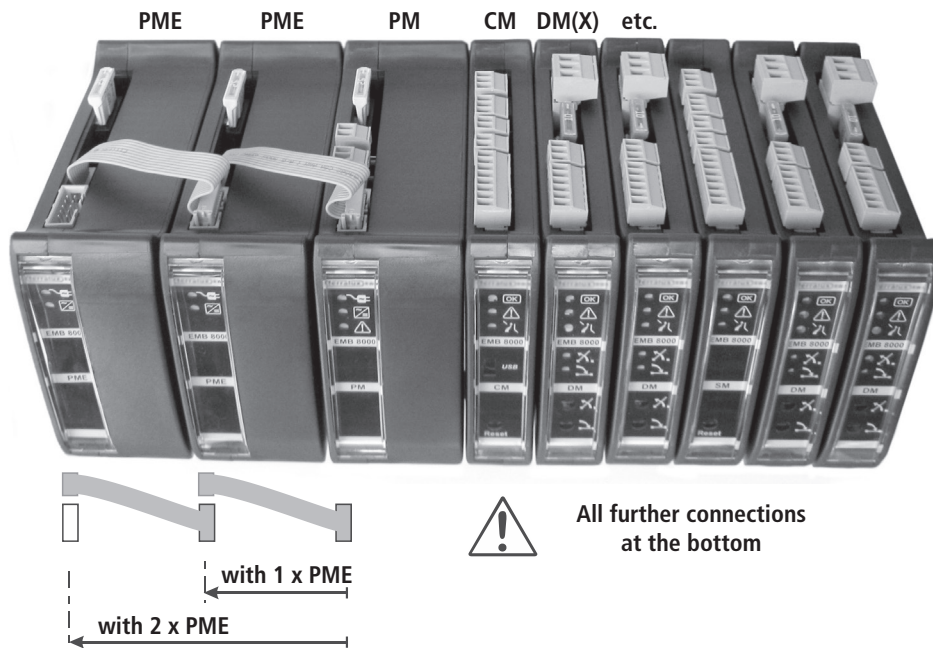

INSTALLATION STEP 3: NETWORKING OF CONTROL UNIT

Basics:

Up to 30 EMB 8000+ Control Units can be networked with one another via the „OnBoard“ CAN bus interface. The maximum cable length for the entire bus segment is 400 meters (cable type Y-St-Y 2 x 2 x 0.8 mm). With different cable types, the maximum cable length can vary significantly. A CAN repeater must be used for longer bus segments.

In order to network the Control Units, the licensed configuration Software Alpha required. The bus topology must always be built up in series,

stub lines or ring lines are not permitted. The shield of the bus cable may only be connected on one side (asymmetrical), the ground of two Control Units may not be connected via the bus cable in order to avoid interference. The integrated terminating resistor (120) must be activated using a DIP switch on the first and last EMB 8000+ in the composite; the integrated resistor must be deactivated using a DIP switch on all other Control Units in the composite.

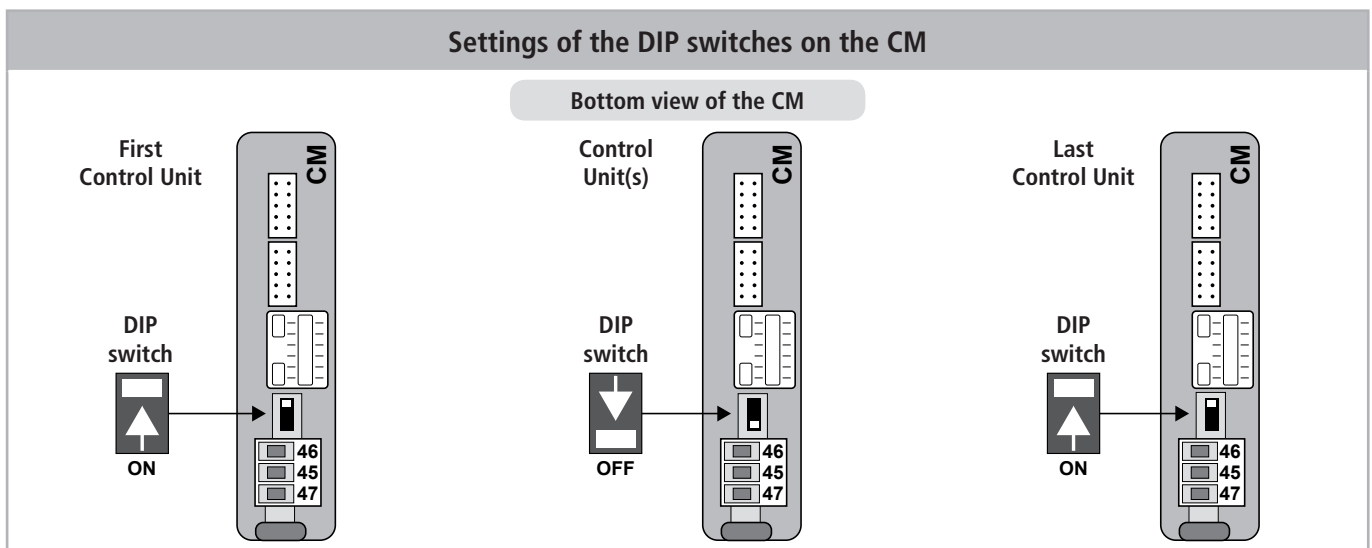
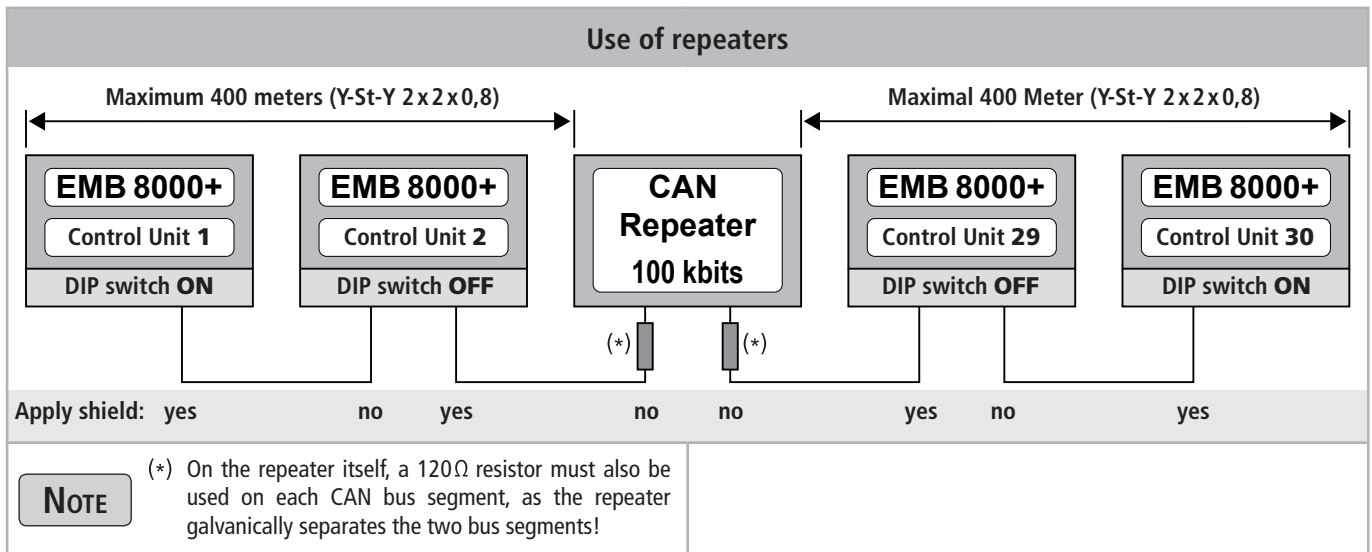
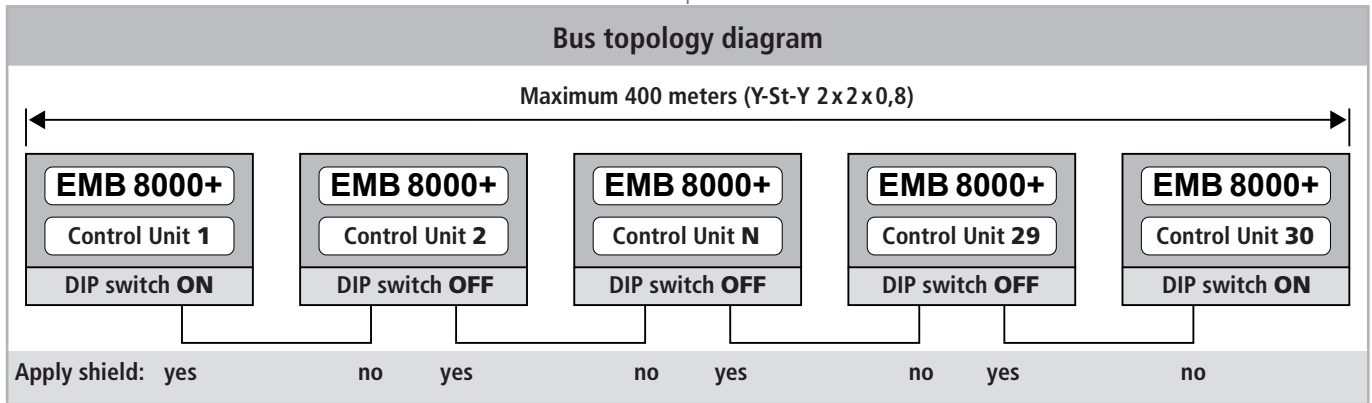

Connection diagram: CAN-composite

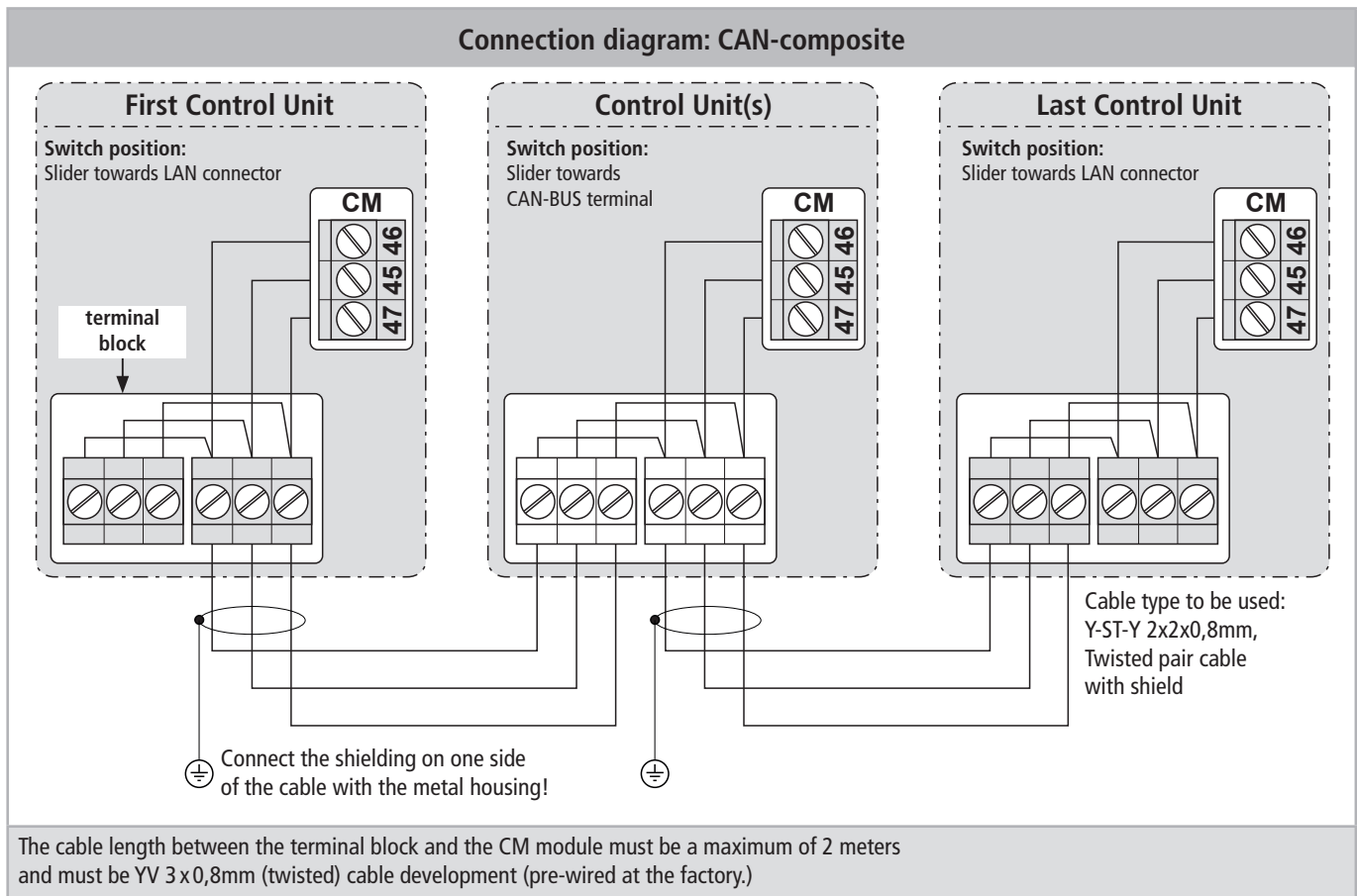

Procedure when setting up a CAN system:

- Set up and assemble all Control Units.
- Lay and connect the bus cables between the system.
- Connect to the first system.
- Start the Alpha configuration software and select the EMB 8000+ plug-in.
- Set and save the CAN address in the „Start options“ (e.g. 1 of 3).
- Repeat this process for all other Control Units (e.g. 2 of 3 and 3 of 3).
- When all CAN addresses have been distributed, the entire network can be read out completely and programming can be started.

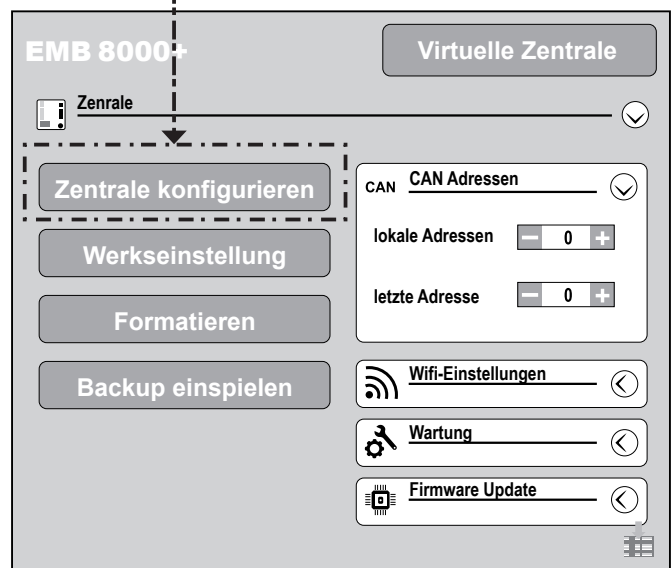
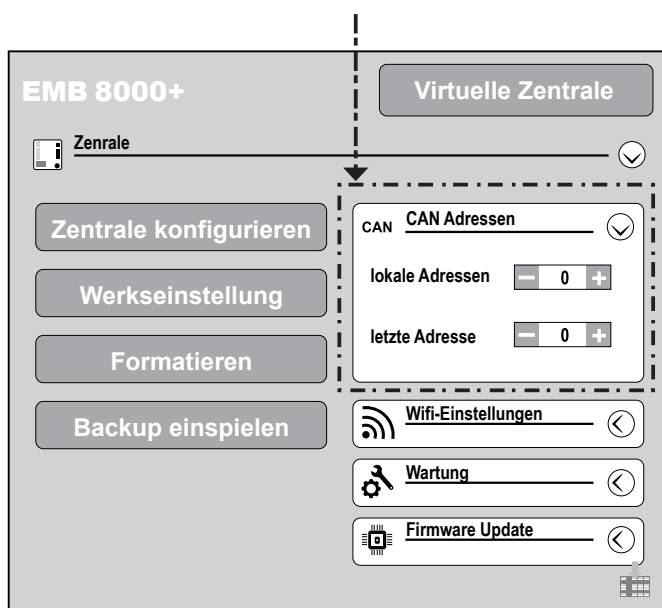

CAN Checklist

CAN Checklist	
<p>What you should definitely check before you configure.</p> <ul style="list-style-type: none"> <input type="checkbox"/> Are all Control Units switched on / under voltage? (Mains and accumulator) <input type="checkbox"/> Are all Control Units correctly addressed? (no address is missing, no address is duplicated) <input type="checkbox"/> Has the wiring been carried out correctly? (Line wiring, no branch or ring lines) <input type="checkbox"/> Has the correct cable been used? [Y-(St)-Y 2 x 2 x 0,8] <input type="checkbox"/> Has the maximum cable length been observed? (400 meters, first to last Control Units) <input type="checkbox"/> Are the DIP switches for the resistors set correctly? (first and last Control Units ON, all others OFF) <input type="checkbox"/> Is the shield of the bus cable correctly applied? (asymmetrical, only one end on the metal housing of the Control Unit, never connect the ground of several control panels via the BUS cable) <input type="checkbox"/> Is the maximum line between the CAN terminal block and the CM 2 meters long and with YV 3 x 0,8mm (twisted)? <input type="checkbox"/> Was the cabling measurement successful? (see test measurement, expected result between 60 and 90 Ω) 	<p>If a repeater is used (due to the length of the cable), the following must also be checked:</p> <ul style="list-style-type: none"> <input type="checkbox"/> Is the repeater correctly set using the dip switch? (100 kbits) <input type="checkbox"/> Have the two end resistors been activated by jumpers on the repeater? (120 Ω) <input type="checkbox"/> The cabling measurement must be carried out for each segment, if all measurements were successful (see test measurement, expected result between 60 and 90 Ω) <div style="background-color: #e0e0e0; padding: 5px; margin-top: 10px;"> <p>All specified values (cable length, resistance at the repeater, measurement results, etc.) always refer to the cable types recommended by AUMÜLLER [Y-(St)-Y 2 x 2 x 0,8 mm]. If you use a different cable type (e.g. JE-H (St) H FE 180 / E90 2x2x0,8mm) please contact us at the planning stage in order to be able to consider possible deviations in cable lengths, resistances, etc. at the planning stage.</p> </div>

Test measurement CAN bus cabling

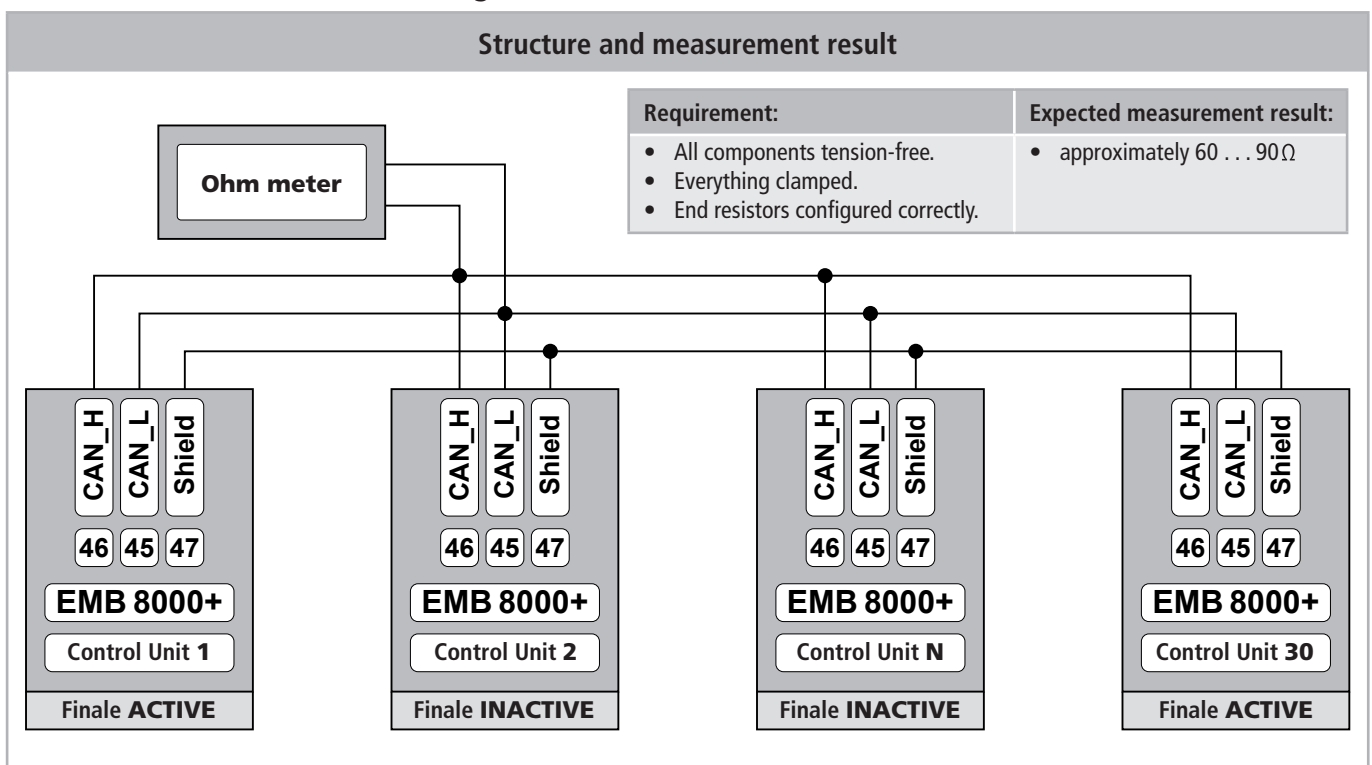

5 A

10 A

24 A

48 A

72 A

OVERVIEW OF CONNECTION OF EXTERNAL COMPONENTS

Allowable connection values:

- A** = display, max. 0,1 A
cable length: max. 400 m
- B** = parallel switching of max. 10 break-glass unit buttons
cable length: max. 400 m
- C** = parallel switching of max. 10 smoke detectors
cable length: max. 400 m
- D** = parallel switching of max. 10 ventilation buttons
cable length: max. 400 m
- E** = potential-free contacts,
max. 42 V, 0,5 A
- F** = sensors, 24V DC, 0,5 A
cable length: max. 400 m
- G** = analogue inputs, 24 V DC, 4 ... 20 mA
cable length: max. 400 m
- H** = other inputs / outputs, 24 V DC, max. 0,5 A
- J** = rain sensor,
cable length: max. 200 m
- K** = current and cable length depends on the drives
- L** = analogue input for sensors
max. 24 V, 0,5 A
- M** = max. 30 participant
(BUS-HM / BUS-RM)
cable length: max. 400 m

Terminal cross section:

min. 0,14 mm² / max. 1,5 mm² for **A / B / C / D / E / F / G / H / J / L / M**
 min. 0,14 mm² / max. 2,5 mm² for **K (drives)**

Line length and cross-section A (drives) depend on the type of drive and on the number of drives. Line length and cross-section can be determined from the following formula:

Formula to calculate

the required wire cross-section of an infeed line

$$A \text{ mm}^2 = \frac{I_{(total)} \times L \text{ m (length infeed line)} \times 2}{\Delta U \text{ V (voltage drop)} \times 56 \text{ m} / (\Omega^* \text{mm}^2)}$$

- A = cross-section of line in mm²
- L = line length in m
- I = current of connected drives in A
- ΔU = line voltage drop = 2 V DC



Cable installation must be in compliance with applicable legal requirements.

Connection: Power-Module PM

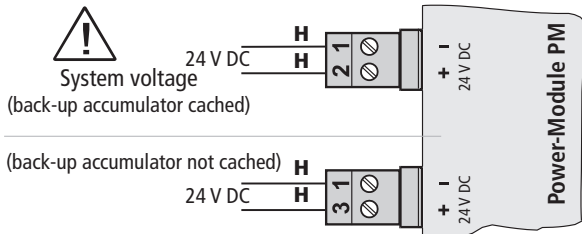

On back-up accumulator cached system connected devices reduces the bridging time and thus requires back-up accumulators with a higher capacity.

Connection: IM-K

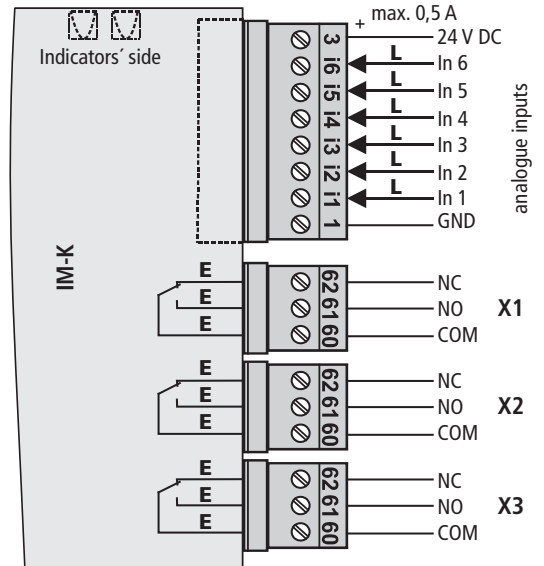

Connection: Control-Module CM

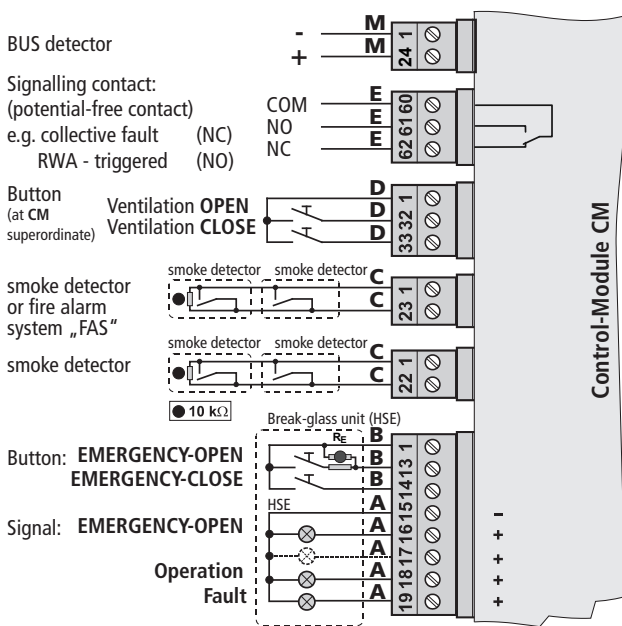

Connection: Sensor-Module SM

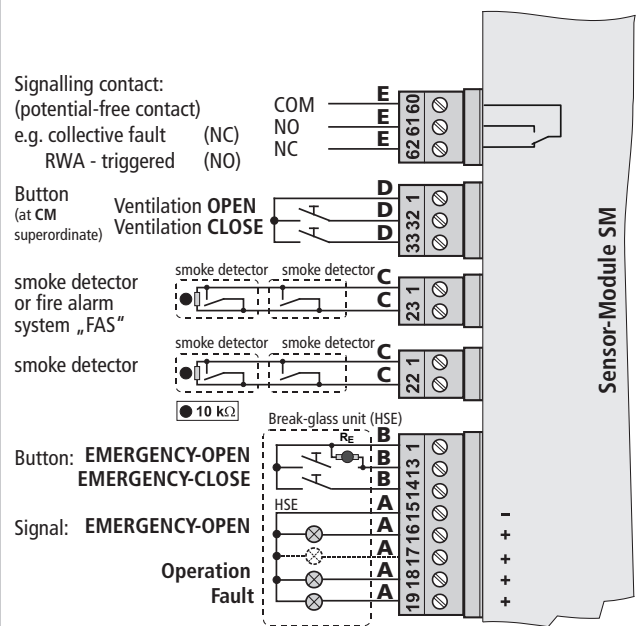

Connection: Drive-Module DM / DMX

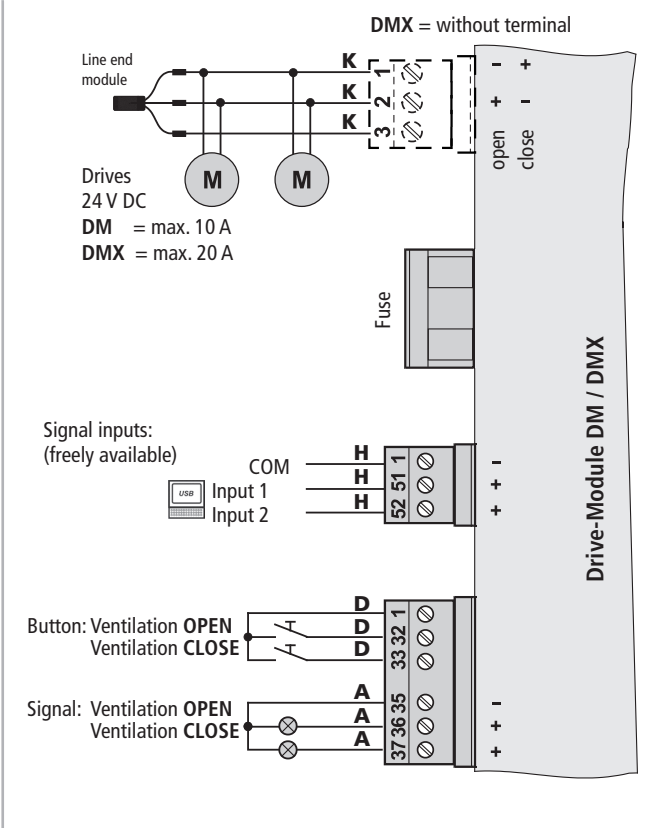

Connection: Intelligent-Drive-Module IDM

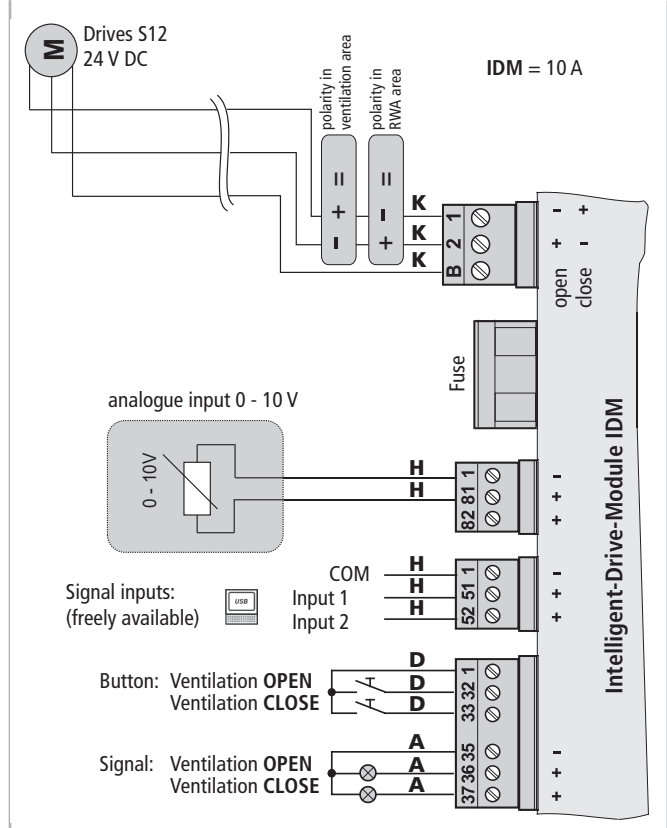

Connection: Relay-Module RM6

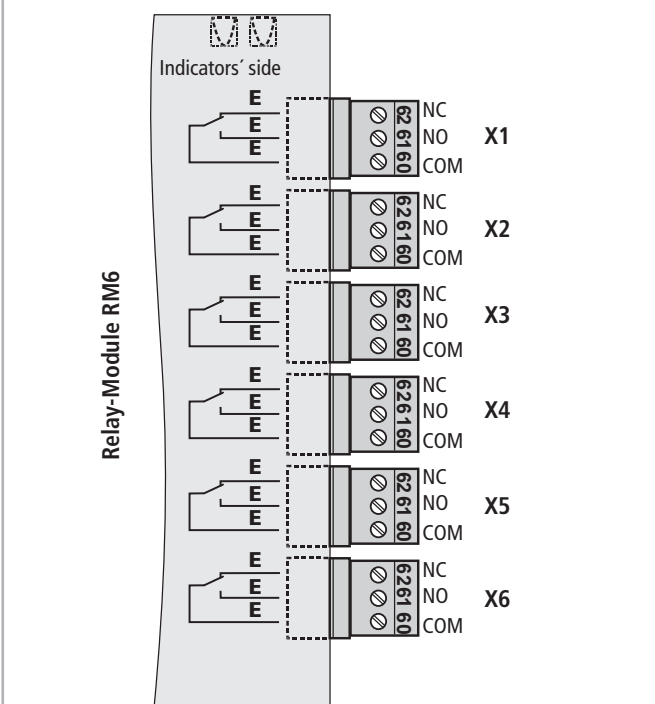

Integrating the module in the internal BUS.
Position behind module PM / PME / CM freely selectable.

Connection: Weather-Module WM

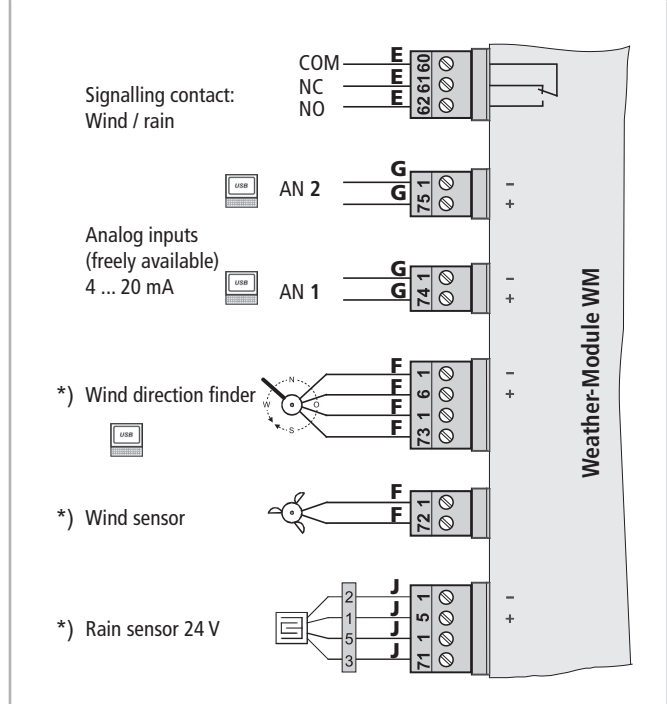

*) When using a wind direction finder, wind and possibly rain sensor must be interconnected with the connection of the wind direction finder.

INSTALLATION STEP 4A: POWER-MODULE-EXTENSION PME

Power-Module-Extension PME



Part.-No.: 688100

Application: Module for the self installation on customer side into the RWA Control Unit EMB 8000+ for monitoring of the main power supply.

Operating voltage: 24 V DC

Internal consumption: 0 mA

Housing (WxD): 100 x 120 x 45 mm, ABS, black

Module units: 2 ME



Displays: Power, status

Connections: Socket and plug with cable for internal BUS

Mounting: Fixing on 35-mm mounting rail.

- Functions:**
- Monitors the main power supply for more than one switching power supply.
 - Switches to back-up accumulator operation during power failure.

Simple LED states

LED	Reaction	Cause
 Status Power supply (green)	ON	Power supply presented
	OFF	Power supply failure
 Status (green)	ON	Power supply operation
	OFF	System is switched off

Connection: Power-Module-Extension PME

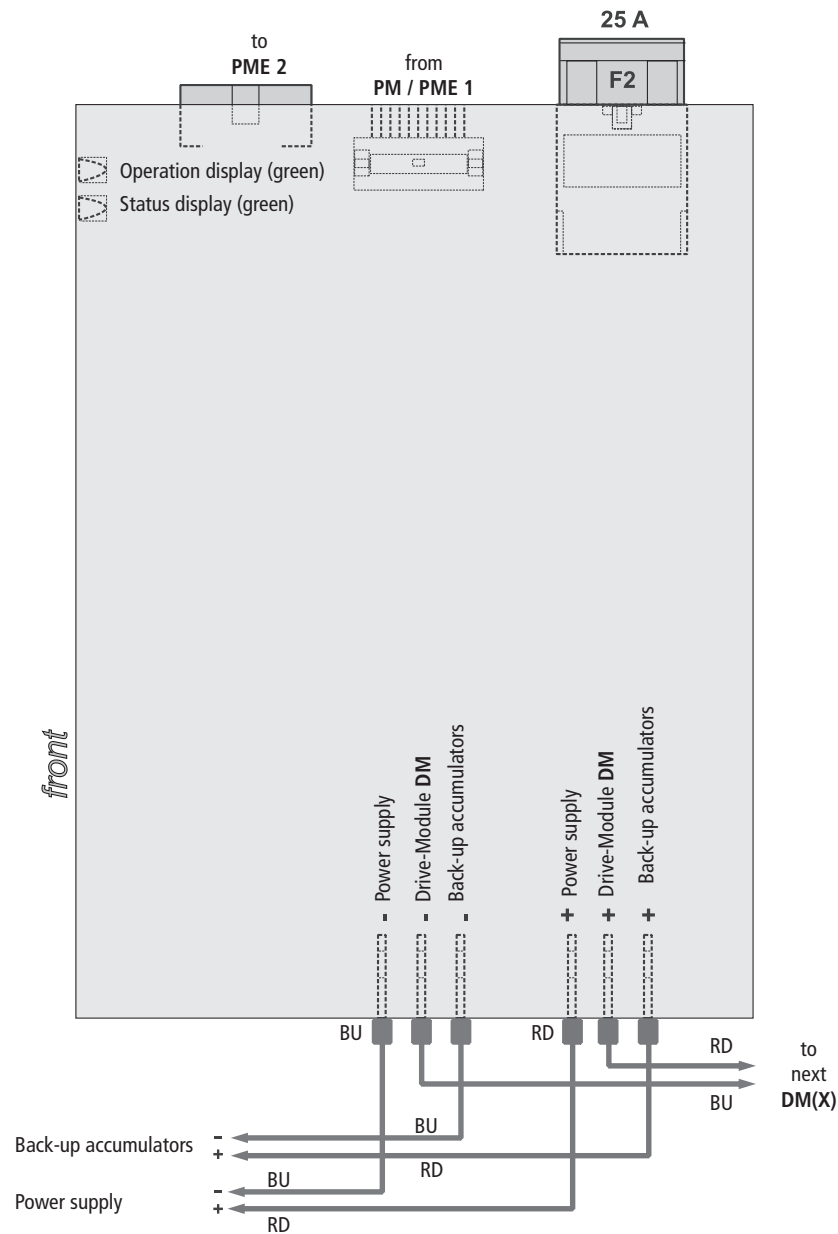

INSTALLATION STEP 4B: POWER-MODULE-EXTENSION PM

Power-Module PM





Part.-No.: 688050
Application: Module for the self installation on customer side into the RWA Control Unit EMB 8000+ for monitoring of the main power supply.

Operating voltage: 24 V DC
Internal consumption: 16,0 mA
Housing (WxD): 100 x 120 x 45 mm, ABS, black
Module units: 2 ME
Displays: Operation, fault, status
Connections: Plug-in terminals 1 mm² (rigid wire), socket and plug with cable for internal BUS
Mounting: Fixing on 35-mm mounting rail.

- Functions:**
- Monitors the main power supply.
 - Controls the charging voltage of the back-up accumulator.
 - Switches to back-up accumulator operation during power failure.
 - Has a connection for a sensor „temperature-dependent charging of back-up accumulators“.

Simple LED states

LED	Reaction	Cause
 Status Power supply (green)	ON	Power supply presented
	OFF	Power supply failure
	fast flashing	Modbus communication malfunction
 Status (green)	ON	Power supply operation
	OFF	System is switched off because of deep discharge
	flash	System in accumulator mode
 Fault (yellow)	ON	F2 or charging circuit is faulty
	OFF	not a fault
	slow flashing	F1 is faulty or accumulator not connected
	fast flashing	Overload shutdown system voltage

Connection: Power-Module PM

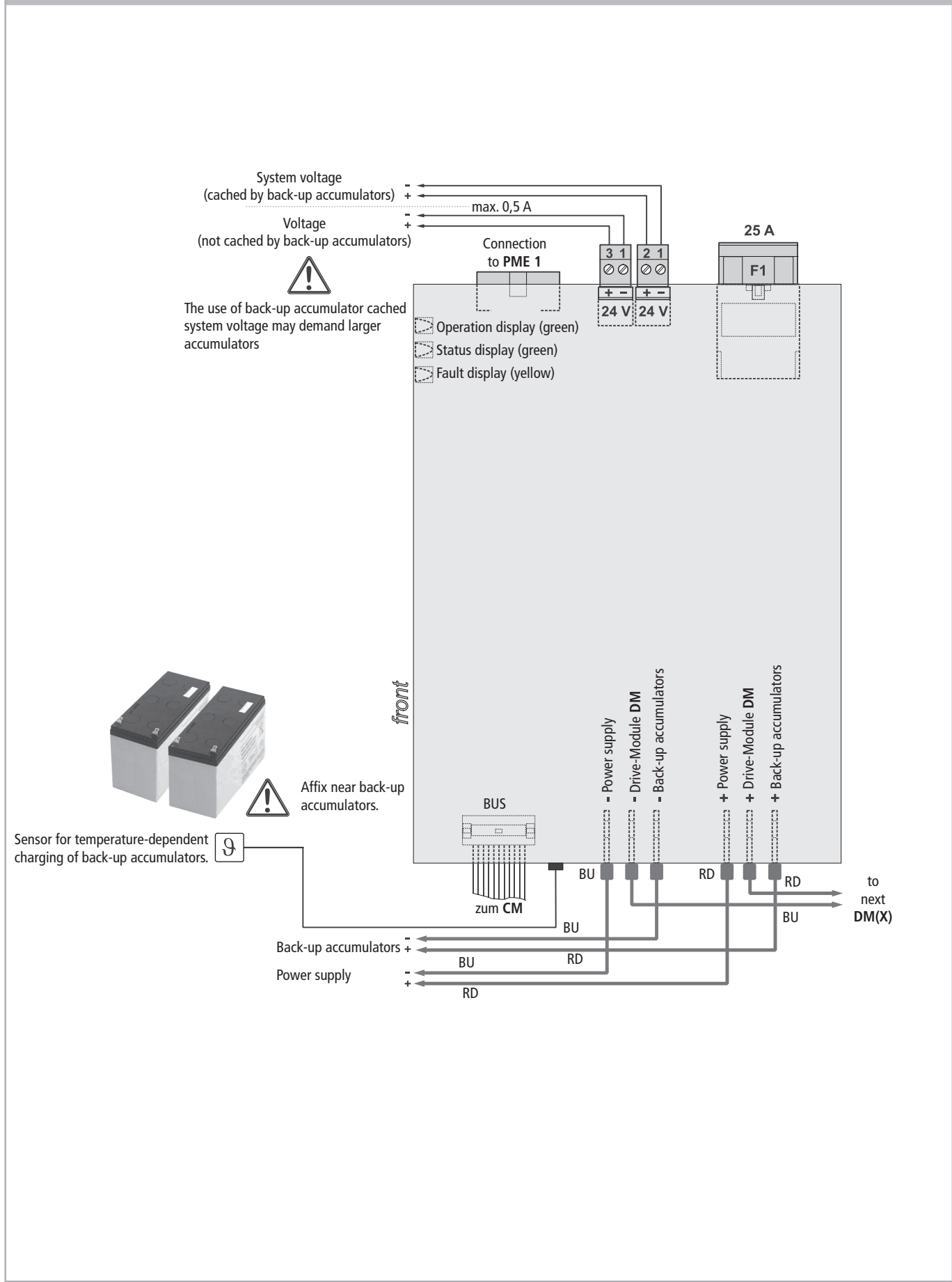

INSTALLATION STEP 5: CONTROL-MODULE CM

Control-Module CM



Part.-No.: 688120
Application: Module for the self installation on customer side into the RWA Control Unit EMB 8000+ for the connecting of automatic smoke detectors and break-glass units.

Operating voltage: 24 V DC
Detector line voltage: 24 V DC
Internal consumption: 34,1 mA

Housing (WxHxD): 100 x 120 x 22,5 mm, ABS, black
Module units: 1 ME

Inputs:
 3 Detector lines (max. 10 detectors / line)
 1 BUS-detector (max. 30 detectors)
 1 Ethernet port
 1 CAN interface
 Ventilation push button (max. 10 pieces)

Outputs:
 1 Feedback contact (change-over switch, 42 V / 0,5 A)



Displays:
 Operation, fault, alarm

Control elements:
 Front push button: Reset

Connections:
 Plug-in terminals 1 mm² (rigid wire),
 socket and plug with cable for internal BUS

Mounting:
 Fixing on 35-mm mounting rail.

- Functions:**
- Monitors three fire signalling lines for triggering and faults.
 - Processes signals from ventilation buttons.
 - Has connections for relaying of external signals for operation, fault and alarm.
 - Belongs to the basic equipment of a Control Unit and must be connected directly with the Power-Module PM via BUS cable.

Simple LED states		
LED	Reaction	Cause
 Operation (green)	ON	Normal operating state
	OFF	Fault present
	fast flashing	Modbus communication malfunction
 Fault (yellow)	ON	Manual fire alarm fault
	OFF	Not a fault
	slow flashing	Smoke detector line 1 is faulty
	fast flashing	Smoke detector line 2 is faulty
	flash	System in accumulator mode
 Alarm (red)	ON	Alarm or Emergency-OPEN
	OFF	Normal operating state
	slow flashing	Smoke detector still active after Emergency-CLOSE
	fast flashing	Manual fire alarm still triggered after Emergency-CLOSE

Combined states		
LED	Reaction	Cause
	Operation (green) continuous flicker. Fault (yellow) is on.	One or more slave modules are missing. This fault will be like treated a collective fault.
■■■■■■	Operation (green) is off. Fault (yellow) interrupted, fast flashing.	Accumulator faults
■ ■	Operation (green) is on. Fault (yellow) pulse flashing, 2 pulses.	Maintenance period expired.
■ ■ ■	Operation (green) is on. Fault (yellow) pulse flashing, 3 pulses.	A CAN participant is missing or one system in the CAN network is disturbed.
■ ■ ■ ■	Operation (green) is on. Fault (yellow) pulse flashing, 4 pulses.	DM overload (only when using CCC panel).
■ ■ ■ ■ ■	Operation (green) is off. Fault (yellow) pulse flashing, 5 pulses.	One BUS HSE is missing or disturbed.

Connection: Control-Module CM

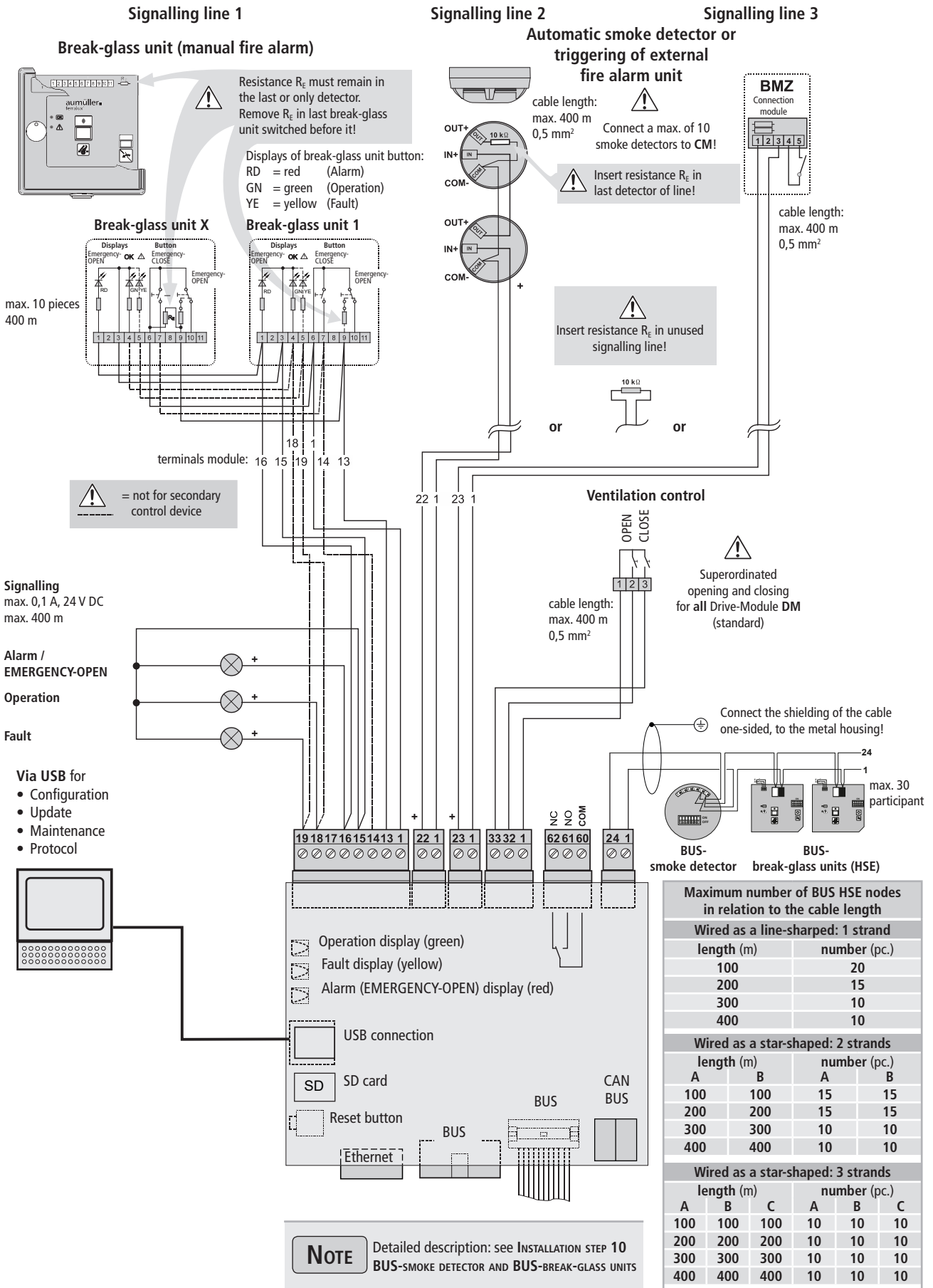

INSTALLATION STEP 6: SENSOR-MODULE SM

Sensor-Module SM



Part.-No.: 688150-9
Application: **Factory fitted module** installed into an RWA Control Unit EMB 8000+ and fully wired, for the connecting of automatic smoke detectors and break-glass units.

Part.-No.: 688150
Application: **Module for the self installation on customer side** into the RWA Control Unit EMB 8000+ for the connecting of automatic smoke detectors and break-glass units.

Operating voltage: 24 V DC
Detector line voltage: 24 V DC
Internal consumption: 12,6 mA

Housing (WxHxD): 100 x 120 x 22,5 mm, ABS, black
Module units: 1 ME
Inputs: 3 Detector lines (max. 10 detectors / line)
1 Ventilation push button (max. 10 pieces)

Outputs: 1 feedback contact (change-over switch, 42 V / 0,5 A)

Displays: Operation, fault, alarm



Control elements: Front push button: Reset

Connections: Plug-in terminals 1 mm² (rigid wire), socket and plug with cable for internal BUS

Mounting: Fixing on 35-mm mounting rail.

- Functions:
- Monitors three fire signalling lines for triggering and faults.
 - Processes signals from ventilation buttons.
 - Has connections for relaying of external signals for operation, fault and alarm.
 - Can only be employed, if a Control-Module **CM** is already present.

Simple LED states

LED	Reaction	Cause
 Operation (green)	ON	Normal operating state
	OFF	Fault present
	fast flashing	Modbus communication malfunction
 Fault (yellow)	ON	Manual fire alarm fault
	OFF	Not a fault
	slow flashing	Smoke detector line 1 is faulty
	fast flashing	Smoke detector line 2 is faulty
	flash	System in accumulator mode
 Alarm (red)	ON	Alarm or Emergency-OPEN
	OFF	Normal operating state
	slow flashing	Smoke detector still active after Emergency-CLOSE
	fast flashing	Manual fire alarm still triggered after Emergency-CLOSE

Connection: Sensor-Module SM

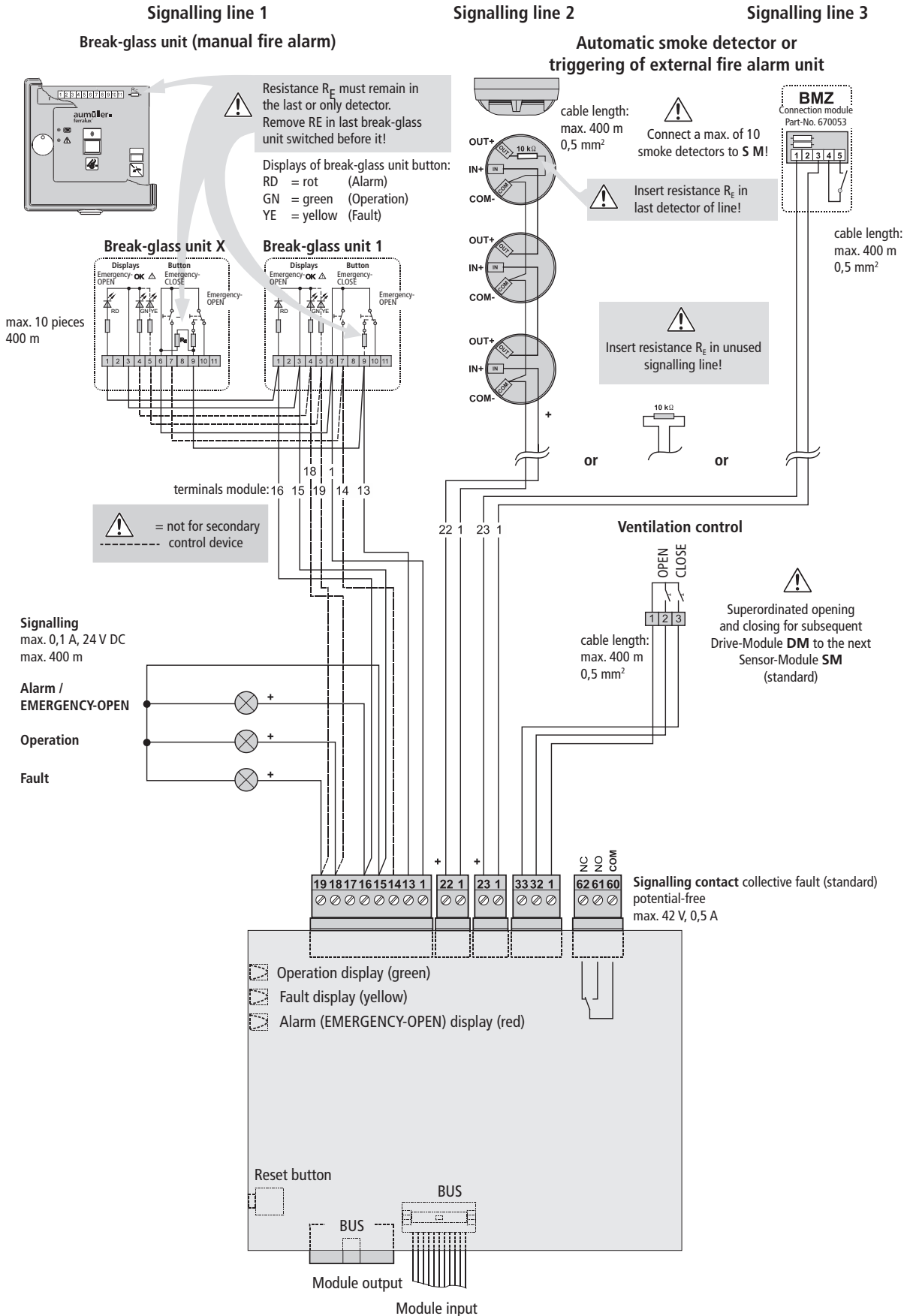

INSTALLATION STEP 7A: DRIVE-MODULE DM

Drive-Module DM

10 A







Part.-No.: 688250-9
Application: **Factory fitted module** installed into an RWA Control Unit EMB 8000+ and fully wired, for the controlling of drives, gas-pressure generators and magnetic locks.

Part.-No.: 688250
Application: **Module for the self installation on customer side** into the RWA Control Unit EMB 8000+ for the controlling of drives, gas-pressure generators and magnetic locks.

Operating voltage: 24 V DC
Output voltage: 24 V DC (20 – 28 V DC / 0,5 Vpp)
Internal consumption: 5,3 mA
Output current: **10 A**
Housing (WxHxD): 100 x 120 x 22,5 mm, ABS, black
Module units: 1 ME
Inputs: Ventilation push button (max. 10 pieces), feedback contact OPEN / CLOSE
Outputs: Drive line (gas-pressure generators / magnetic locks)
Displays: Operation, fault, alarm, running direction OPEN / CLOSE
Control elements: Front push button: OPEN / CLOSE
Connections: Plug-in terminals 1 mm² (rigid wire), Drives: 2,5 mm², Blade terminals 6,3 mm: voltage supply, socket and plug with cable for internal BUS
Mounting: Fixing on 35-mm mounting rail.

- Functions:**
- Has a connection for electromotive AUMÜLLER S12/S3 drives up to max. **10 A**
 - With appropriate programming, triggering of gas pressure generators or magnetic clamps is also possible.
 - The drive line is being monitored by closed-circuit current (short circuit, interruption).
 - Processes signals from ventilation buttons and if needed line end signals from drives.
 - Has connections for external relaying of line end status signal.

Simple LED states

LED	Reaction	Cause
 Operation (green)	ON	Normal operating state
	OFF	Fault present
	fast flashing	Modbus communication malfunction
 Fault (yellow)	ON	Fault Motor line / voltage supply
	OFF	Not a fault
 Alarm (red)	ON	Alarm or Emergency-OPEN
	OFF	Normal operating state
	flash	Alarm on accumulator operation
 OPEN (red)	ON	OPEN-Relay on
	OFF	OPEN-Relay off
 CLOSE (green)	ON	CLOSE-Relay on
	OFF	CLOSE-Relay off

Connection: Drive-Module DM (10A)

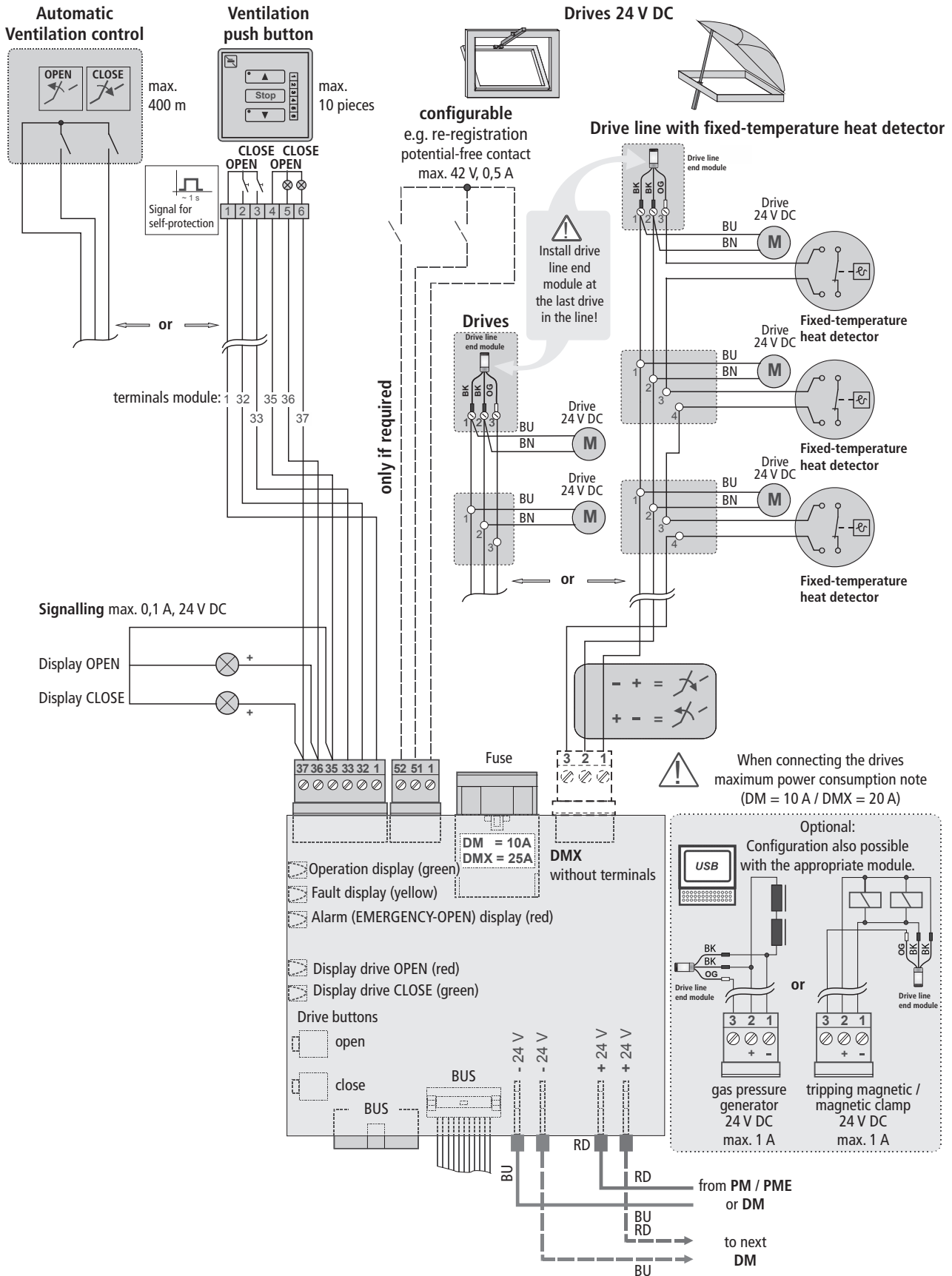

INSTALLATION STEP 7B: 230V-DRIVE-MODULE VENT

230V-Drive-Module Vent

5 A



Part.-No.: 688280-9
Application: Factory fitted module installed into an RWA Control Unit EMB 8000+ and fully wired, for the controlling of 230 V AC drives.

Part.-No.: 688280
Application: Module for the self installation on customer side into the RWA Control Unit EMB 8000+ for the controlling of 230 V AC drives.

Operating voltage: 230 V AC
Output voltage: 230 V AC
Internal consumption: 7,0 mA
Output current: 5 A

Housing (WxHxD): 100 x 120 x 22,5 mm, ABS, black

Module units: 1 ME

Inputs: Ventilation push button (max. 10 pieces), feedback contact OPEN / CLOSE

Outputs: Drive line (gas-pressure generators / magnetic locks)

Displays: Operation, fault, alarm, running direction OPEN / CLOSE

Control elements: Front push button: OPEN / CLOSE





Connections: Plug-in terminals 1 mm² (rigid wire), Drives: 2,5 mm², socket and plug with cable for internal BUS

Mounting: Fixing on 35-mm mounting rail.

Built-in fuse: 5AT 5*20 mm

- Functions:
- Has a connection for electromotive drives up to max. 5 A
 - The drive line is monitored for interruptions.
 - Processes signals from ventilation buttons and if needed line end signals from drives.
 - Has connections for external relaying of line end status signal.

Simple LED states

LED	Reaction	Cause
 Operation (green)	ON	Normal operating state
	OFF	Fault present
	fast flashing	Modbus communication malfunction
 Fault (yellow)	ON	Fault Motor line / voltage supply
	OFF	Not a fault
 Alarm (red)	ON	Alarm or Emergency-OPEN
	OFF	Normal operating state
	flash	Alarm on accumulator operation
 OPEN (red)	ON	OPEN-Relay on
	OFF	OPEN-Relay off
 CLOSE (green)	ON	CLOSE-Relay on
	OFF	CLOSE-Relay off

Connection: 230V-Drive-Module Vent (5A)

Automatic Ventilation control

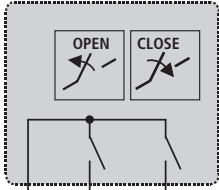

max. 400 m

Ventilation push button

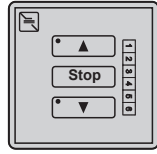

max. 10 pieces



configurable
e.g. re-registration
potential-free contact
max. 42 V, 0,5 A

Connect the monitoring wire (D)
- in the last or only junction box -
with the (N) neutral conductor

terminals module:

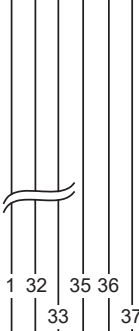
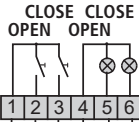

only if required

Signalling max. 0,1 A, 24 V DC

Display OPEN
Display CLOSE

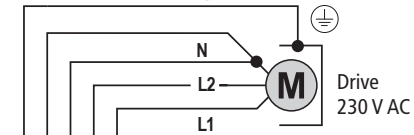

Drive

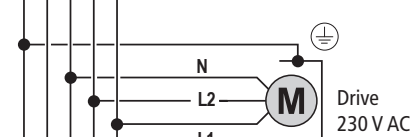

Drive 230 V AC

⚠ When connecting the drives
maximum power consumption
note 5 A

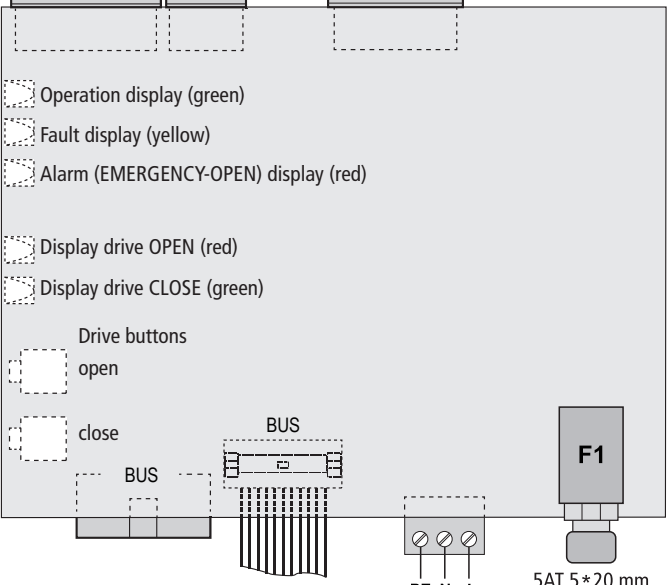
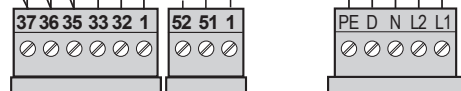

5AT 5*20 mm

INSTALLATION STEP 7C: DRIVE-MODULE DMX

Drive-Module DMX

20 A







Part.-No.: 688255-9
Application: **Factory fitted module** installed into an RWA Control Unit EMB 8000+ and fully wired, for the controlling of drives, gas-pressure generators and magnetic locks.

Part.-No.: 688255
Application: **Module for the self installation on customer side** into the RWA Control Unit EMB 8000+ for the controlling of drives, gas-pressure generators and magnetic locks.

Operating voltage: 24 V DC
Output voltage: 24 V DC (20 – 28 V DC / 0,5 Vpp)
Internal consumption: 5,3 mA
Output current: **20 A**
Housing (WxHxD): 100 x 120 x 45 mm, ABS, black
Module units: 2 ME
Inputs: Ventilation push button (max. 10 pieces), feedback contact OPEN / CLOSE
Outputs: Drive line (gas-pressure generators / magnetic locks)
Displays: Operation, fault, alarm, running direction OPEN / CLOSE
Control elements: Front push button: OPEN / CLOSE
Connections: Plug-in terminals 1 mm² (rigid wire), Blade terminals 6,3 mm: Drives + voltage supply, socket and plug with cable for internal BUS
Mounting: Fixing on 35-mm mounting rail.

- Functions:**
- Has a connection for electromotive AUMÜLLER S12/S3 drives up to max. **20 A**
 - With appropriate programming, triggering of gas pressure generators or magnetic clamps is also possible.
 - The drive line is being monitored by closed-circuit current (short circuit, interruption).
 - Processes signals from ventilation buttons and if needed line end signals from drives.
 - Has connections for external relaying of line end status signal.

Simple LED states

LED	Reaction	Cause
 Operation (green)	ON	Normal operating state
	OFF	Fault present
	fast flashing	Modbus communication malfunction
 Fault (yellow)	ON	Fault Motor line / voltage supply
	OFF	Not a fault
 Alarm (red)	ON	Alarm or Emergency-OPEN
	OFF	Normal operating state
	flash	Alarm on accumulator operation
 OPEN (red)	ON	OPEN-Relay on
	OFF	OPEN-Relay off
 CLOSE (green)	ON	CLOSE-Relay on
	OFF	CLOSE-Relay off

Connection: Drive-Module DMX (20A)

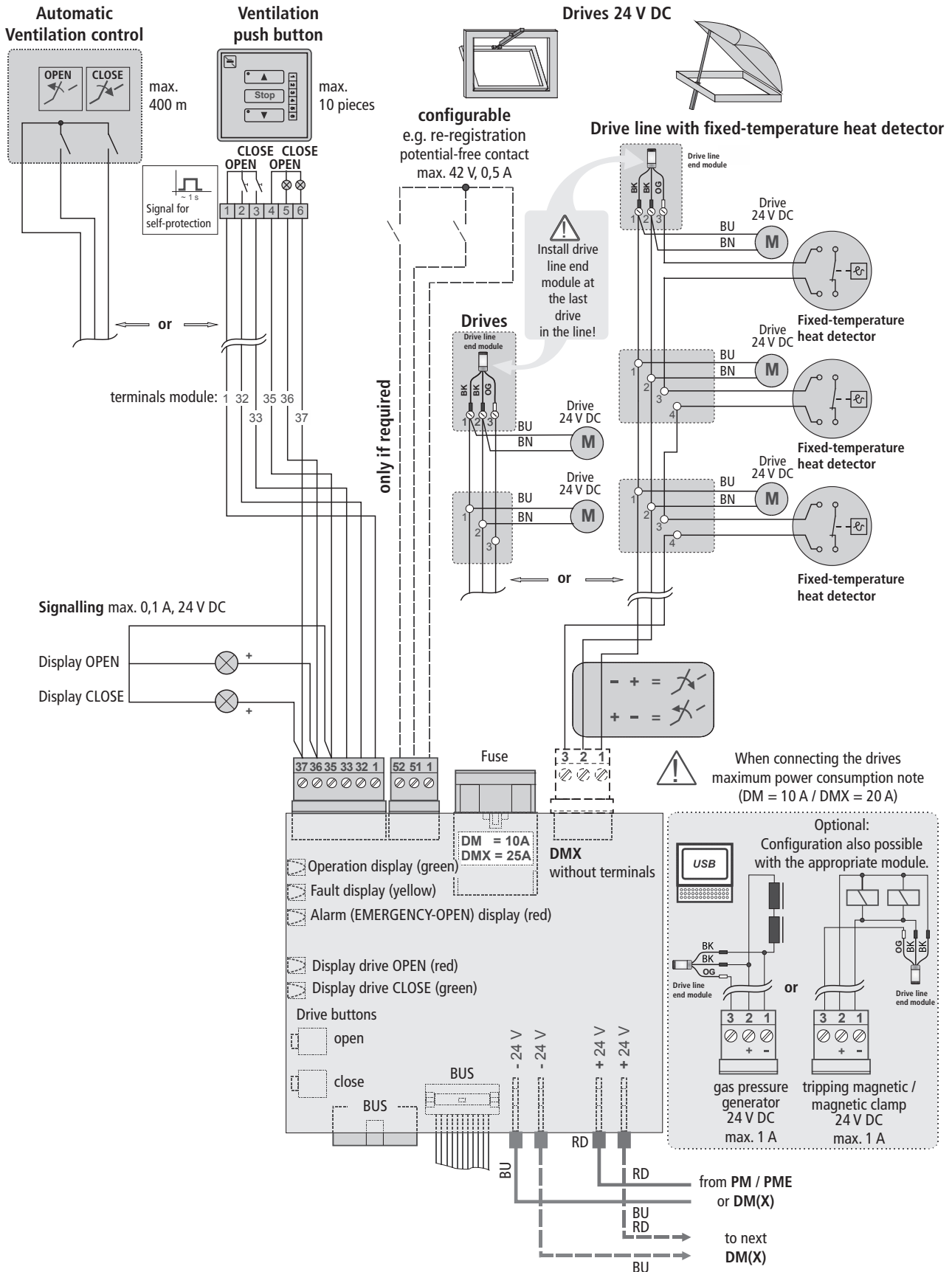

05

INSTALLATION STEP 7C: INTELLIGENT-DRIVE-MODULE IDM

Intelligent-Drive-Module IDM

10 A







Part.-No.: 688257-9
Application: **Factory fitted module** installed into an RWA Control Unit EMB 8000+ and fully wired, for operating intelligent AUMÜLLER S12/S3 drives up to max. **10 A** total current.

Part.-No.: 688257
Application: **Module for the self installation on customer side** for operating intelligent AUMÜLLER S12/S3 drives up to max. **10 A** total current.

Operating voltage: 24 V DC
Output voltage: 24 V DC (20 – 28 V DC / 0,5 Vpp)
Internal consumption: 6 mA
Output current: **10 A**
Housing (WxHxD): 100 x 120 x 22,5 mm, ABS, black
Module units: 1 ME
Inputs: Ventilation push button (max. 10 pieces), feedback contact OPEN / CLOSE, 0 - 10 V analogue input
Outputs: Drive line (AUMÜLLER S12 / S3)
Displays: Operation, Fault, Emergency-OPEN, running direction OPEN / CLOSE
Control elements: Front push button: OPEN / CLOSE
Connections: Plug-in terminals 1 mm² (rigid wire), Drives: 2,5 mm² Blade terminals 6,3 mm: voltage supply, socket and plug with cable for internal BUS, 0-10 V analogue input
Mounting: Fixing on 35-mm mounting rail.

- Functions:**
- It has a connector for electric motor AUMÜLLER S12/S3 drives up to max. **10 A**.
 - The drive line is through a **communication wire** to fault (short circuit, open circuit) monitors.
 - Processes signals from **ventilation buttons** and if needed **line end signals** from drives.
 - Has connections for **external relaying** of line end status signal.
 - Has a direct **0 - 10 V** analogue input for connection to a control voltage.
 - 2 configurable inputs (**24 V DC, 0,5 A**)
 - Intrusion of **GLT - contact**
 - Exact positioning of drives via **BUS** system.

Simple LED states

LED	Reaction	Cause
 Operation (green)	ON	Normal operating state
	OFF	Fault present
	fast flashing	Modbus communication malfunction
 Fault (yellow)	ON	Fault Motor line / voltage supply
	OFF	Not a fault
 Alarm (red)	ON	Alarm or Emergency-OPEN
	OFF	Normal operating state
	flash	Alarm on accumulator operation
 OPEN (red)	ON	Drive(s) opened
	OFF	Not opened
	slow flashing	Drive(s) move opened
 CLOSE (green)	ON	Drive(s) closed
	OFF	Not closed
	slow flashing	Drive(s) move closed

Connection: Intelligent-Drive-Module IDM

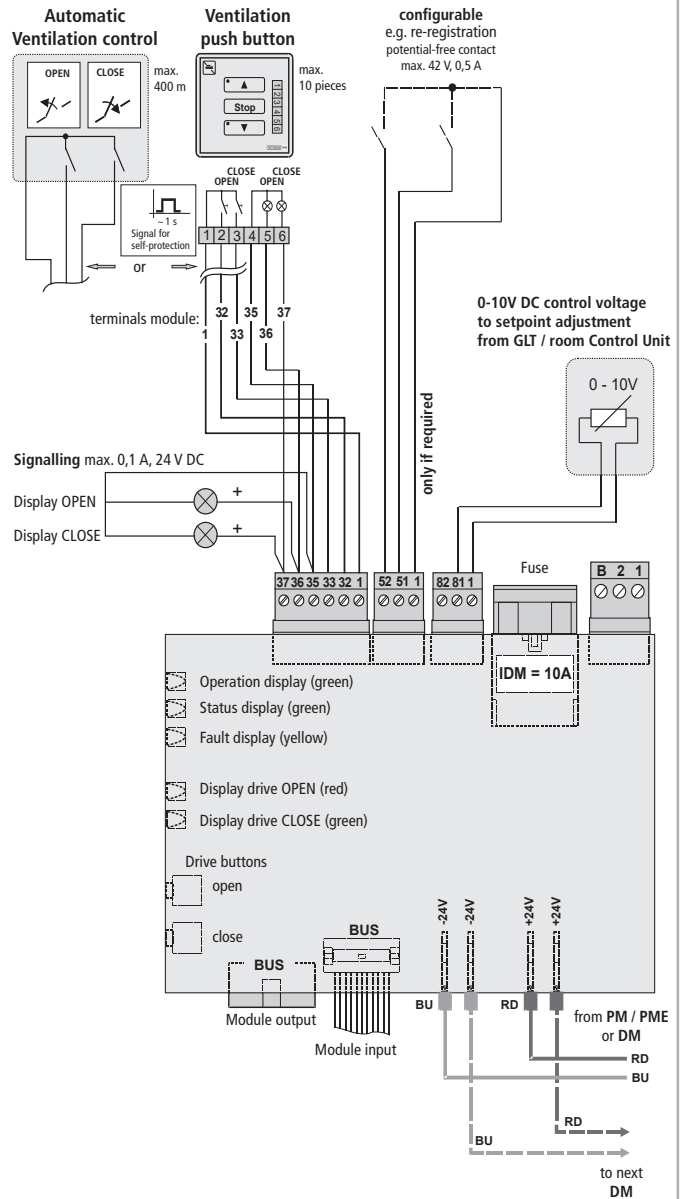
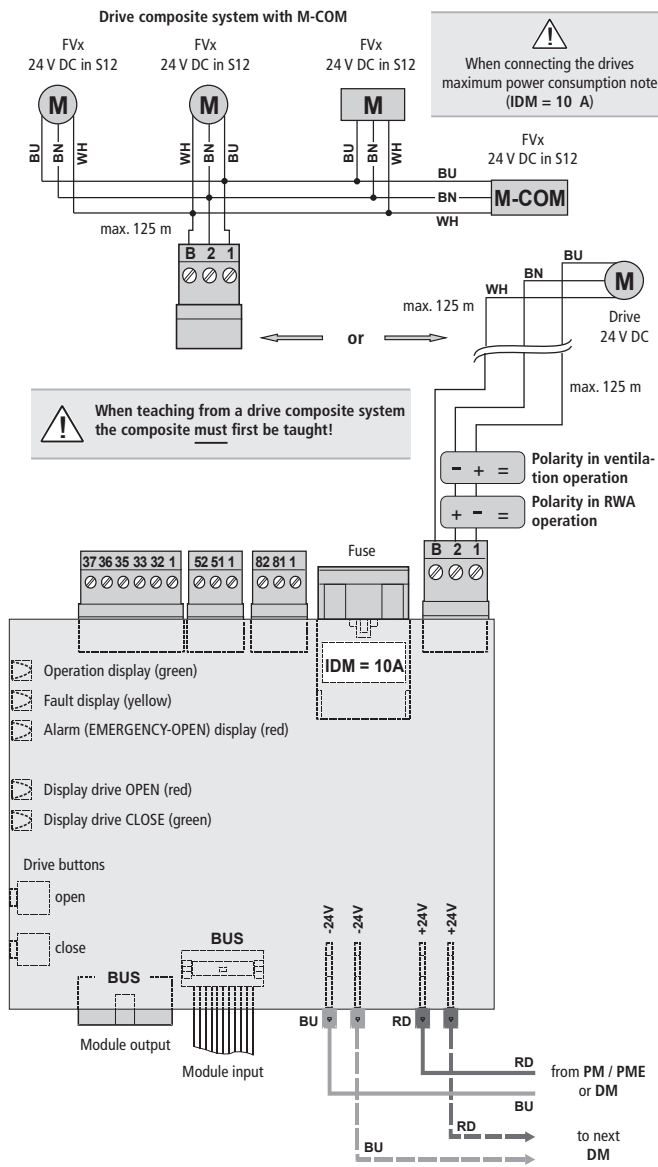

Licensed software is mandatory for use with the Intelligent-Drive-Module IDM is a licensed Software mandatory!

Note when operating with M-COM:

If a M-COM is installed in the drive composite system, the complete composite must be set up with the M-COM and learned first. Only then can the drive composite system to be programmed.

0 - 10 V switching device:

You can give the 0 - 10 V switching device, when it operates with a supply voltage of 24 V connect directly to the back-up accumulator not cached output of the Power-Module PM.

Re-programming the drive system:

Whenever a new drive or a new composite system is connected to the IDM (this also applies when replacing a drive), the drive system must be re-programmed. This is necessary to ensure accurate positioning and feedback of the drive.

This is tripped „RE-PROGRAMMING THE DRIVE SYSTEM“ with the button, find it on the IDM status page. One click is enough and the drive detection starts. Duration of this process for about 15 seconds - then the IDM and the drive system is ready for use.

Normal operation:

The voltage is constant in CLOSE direction on the drive. Choosing the wrong direction, feedback, speed, or the same can be controlled via the communication wire.

RWA operation:

The IDM is to BUS communication on a pole reversal process, the drive will be approached at full speed in the OPEN direction. After resetting the RWA condition, the system returns to normal operation.

INSTALLATION STEP 8A: RELAY-MODULE RM6

Relay-Module RM6





Part.-No.: 688200-9
Application: **Factory fitted module** installed into an RWA Control Unit EMB 8000+ and fully wired, for the transmitting of signals via potential-free relay contacts.

Part.-No.: 688200
Application: **Module for the self installation on customer side** into the RWA Control Unit EMB 8000+ for the transmitting of signals via potential-free relay contacts.

Operating voltage: 24 V DC
Internal consumption: 5,3 mA
Housing (WxHxD): 100 x 120 x 22,5 mm, ABS, black
Module units: 1 ME
Outputs: 6 potential-free relay contacts (change-over switch, 42V / 0,5A)
Displays: Operation, fault
Connections: Plug-in terminals 1 mm² (rigid wire), socket and plug with cable for internal BUS
Mounting: Fixing on 35-mm mounting rail.

- Functions:**
- For the transmitting of signals via potential-free relay contacts.
 - Configuration of the functional and performance features via configuration software EMB 8000+

Simple LED states

LED	Reaction	Cause
 Operation (green)	ON	Normal operating state
	OFF	Fault present
	fast flashing	Modbus communication malfunction
 Fault (yellow)	ON	Supply voltage malfunction
	OFF	Not a fault

Connection: Relay-Module RM6



For the use of
Relay-Module RM6
is a licensed Software
mandatory!

Relay contacts potential-free:

e.g. fault, EMERGENCY-OPEN

Contact load: max. 42V, 0,5A

Terminals: max. 1,0 mm²

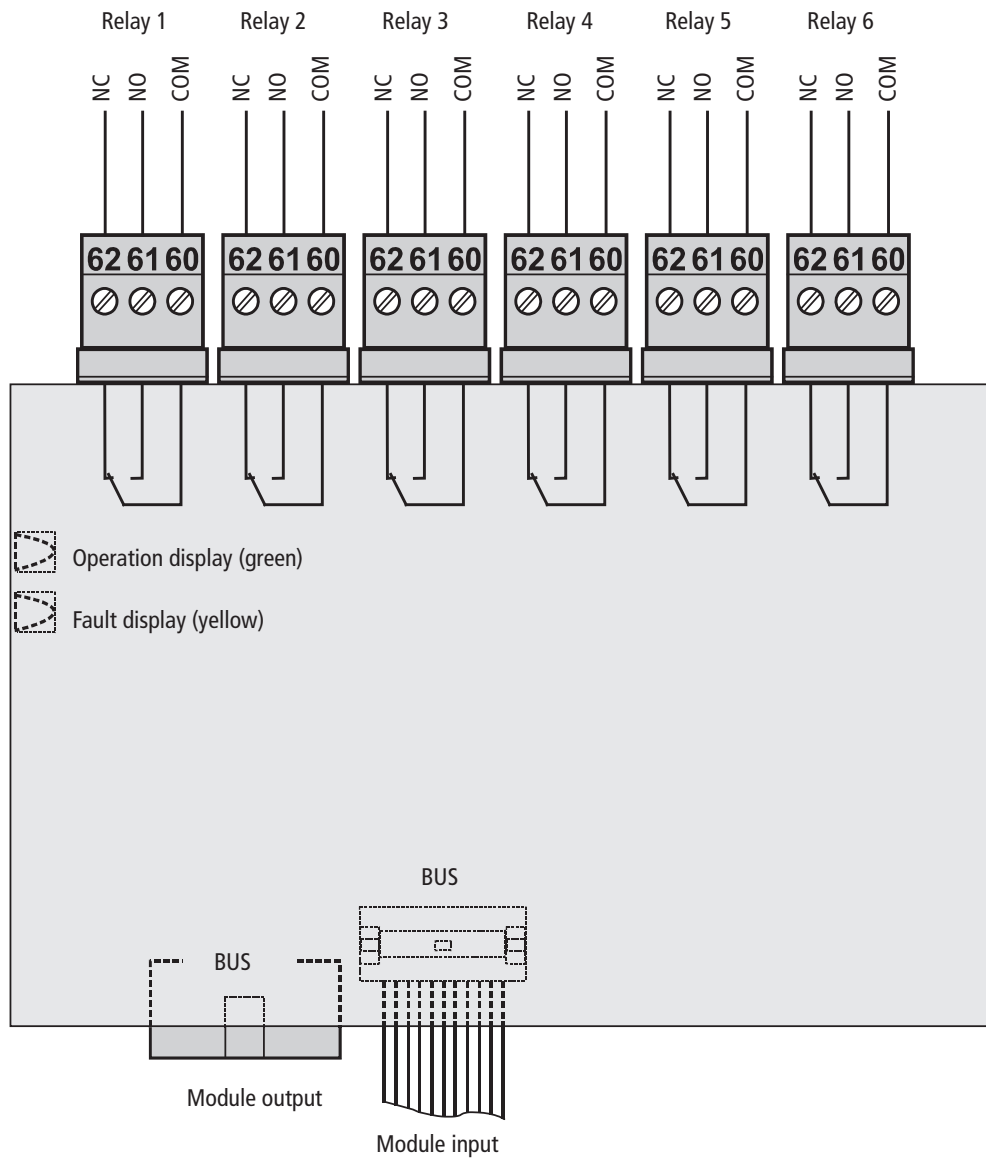

INSTALLATION STEP 8B: KNX-MODULE IM-K

KNX-Module IM-K





Part.-No.: 688265-9
Application: **Factory fitted module** installed into an RWA Control Unit EMB 8000+ and fully wired, for communication between the AUMÜLLER Control Unit EMB 8000+ and the KNX-BUS System.

Part.-No.: 688265
Application: **Module for the self installation on customer side** into the RWA Control Unit EMB 8000+ for communication between the AUMÜLLER Control Unit EMB 8000+ and the KNX-BUS System.

Operating voltage: 24 V DC
Internal consumption: 6 mA
BUS-Strom: 9 mA
Data points: up to 16 lines with up to 16 data points
Housing (WxHxD): 100 x 120 x 22,5 mm, ABS, black
Module units: 1 ME
Inputs: 6 analogue inputs KNX sided,
KNX-BUS terminal
Outputs: 3 potential-free relay contacts via KNX
Displays: Operation, fault, KNX-programming LED
Control elements: KNX-programming button
Connections: Plug-in terminals 1 mm² (rigid wire), socket and plug with cable for internal BUS
Mounting: Fixing on 35-mm mounting rail.

- Functions:**
- Communication module between the Control Unit **EMB 8000+** and a **KNX-BUS** system.
 - Execute commands from the KNX system directly to the Control Unit **EMB 8000+** (e.g. position movements, different running speeds).
 - Sends check back indications to the KNX-BUS system about the state of the Control Unit (e.g. maintenance, operation, fault).
 - Sends check back indications to the KNX-BUS system about the state of the drives (e.g. position, speed, fault).

Simple LED states

LED	Reaction	Cause
 Operation (green)	ON	Normal operating state
	OFF	Fault present
	fast flashing	Modbus communication malfunction
 Fault (yellow)	ON	Fault
	OFF	not a fault

Connection: KNX-Module IM-K

6x Analogue input for sensors:
e.g. temperature, CO2, 0-10V, etc.
max. 24 V, 0,5 A

Relay contacts potential-free:
max. 42V, 0,5 A

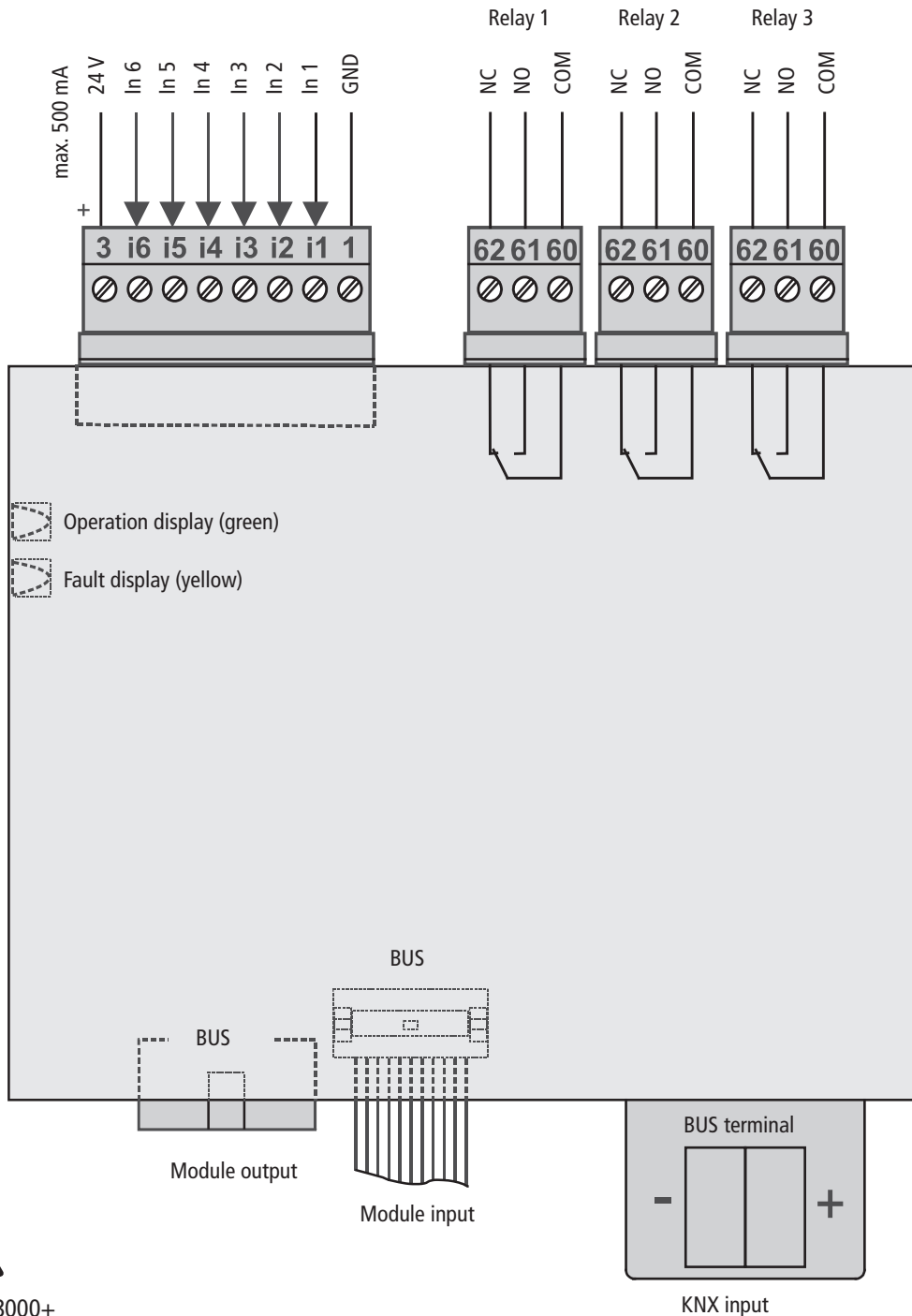

A licensed EMB 8000+ and ETS software are mandatory for use of a KNX-Interface-Module IM-K!

INSTALLATION STEP 9: WEATHER-MODULE WM

Weather-Module WM



Part.-No.: 688180-9
Application: Factory fitted module installed into an RWA Control Unit EMB 8000+ and fully wired, for the connecting of weather sensors.





Part.-No.: 688180
Application: Module for the self installation on customer side into the RWA Control Unit EMB 8000+ for the connecting of weather sensors.

Operating voltage: 24 V DC
Detector line voltage: 24 V DC
Internal consumption: 13,0 mA
Housing (WxHxD): 100 x 120 x 22,5 mm, ABS, black
Module units: 1 ME

Inputs: Wind sensor, rain sensor, wind direction finder, external signals
Outputs: Volt free relay contact (change-over switch, 42V / 0,5A)
Displays: Operation, Fault, Wind, Rain
Connections: Plug-in terminals 1,5 mm² starr
Mounting: Fixing on 35-mm mounting rail.

- Functions:
- Has a connection possibility for wind and rain sensor.
 - Has a wind direction finder for wind-dependent opening and closing in case of fire.
 - Processes signals from external ventilation controls.
 - Has connection for external relaying of signals.

Simple LED states

LED	Reaction	Cause
 Operation (green)	ON	Normal operating state
	OFF	Fault present
	fast flashing	Modbus communication malfunction
 Fault (yellow)	ON	Detector supply malfunction
	OFF	Not a fault
 Rain (red)	ON	Rain contact closed
	OFF	Rain contact opened (no rain)
 Wind (red)	ON	Wind threshold exceeded
	OFF	No significant wind
	slow flashing	Prevailing wind was recognised
	fast flashing	Wind threshold exceeded and main wind direction detected

Connection: Wind and rain sensor to Weather-Module WM

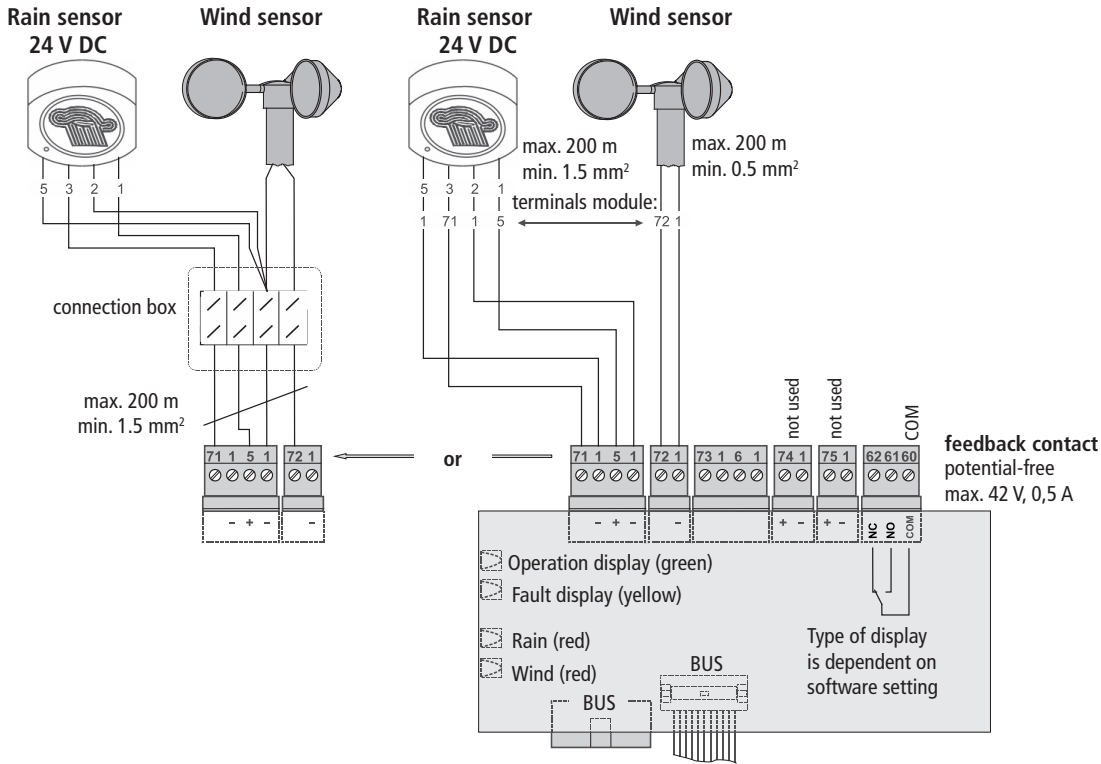

Connection: Wind direction-dependent opening and closing

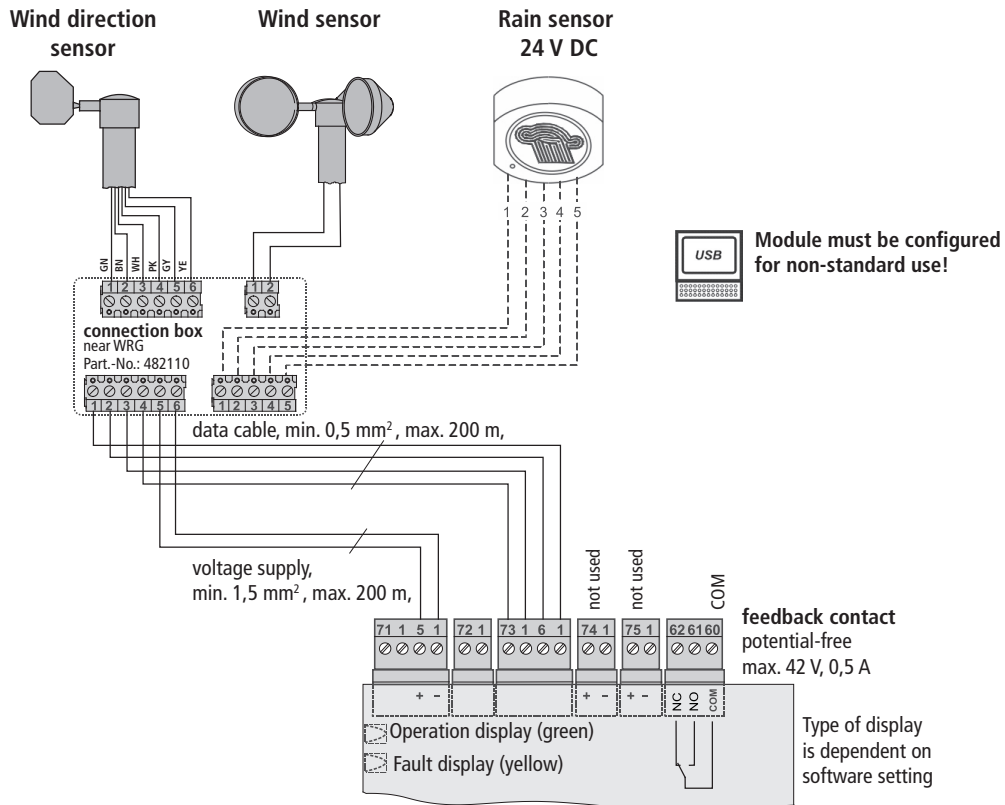

INSTALLATION STEP 10:

BUS-SMOKE DETECTOR AND BUS-BREAK-GLASS UNITS (HSE)

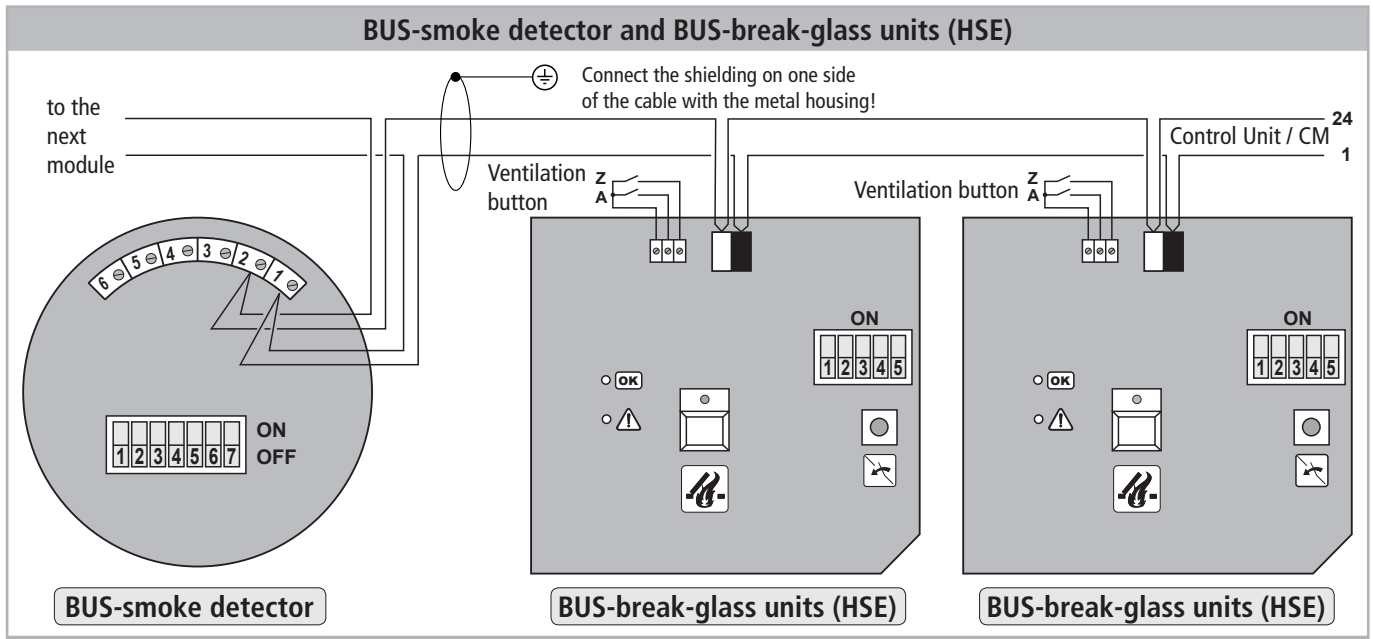

DIP switch:

Address	1	2	3	4	5	6	7	9	10
1	ON	OFF	OFF	OFF	OFF	OFF	ON	OFF	ON
2	OFF	ON	OFF	OFF	OFF	OFF	ON	OFF	ON
3	ON	ON	OFF	OFF	OFF	OFF	ON	OFF	ON
4	OFF	OFF	ON	OFF	OFF	OFF	ON	OFF	ON
5	ON	OFF	ON	OFF	OFF	OFF	ON	OFF	ON
6	OFF	ON	ON	OFF	OFF	OFF	ON	OFF	ON
7	ON	ON	ON	OFF	OFF	OFF	ON	OFF	ON
8	OFF	OFF	OFF	ON	OFF	OFF	ON	OFF	ON
9	ON	OFF	OFF	ON	OFF	OFF	ON	OFF	ON
10	OFF	ON	OFF	ON	OFF	OFF	ON	OFF	ON
11	ON	ON	OFF	ON	OFF	OFF	ON	OFF	ON
12	OFF	OFF	ON	ON	OFF	OFF	ON	OFF	ON
13	ON	OFF	ON	ON	OFF	OFF	ON	OFF	ON
14	OFF	ON	ON	ON	OFF	OFF	ON	OFF	ON
15	ON	ON	ON	ON	OFF	OFF	ON	OFF	ON
16	OFF	OFF	OFF	OFF	ON	OFF	ON	OFF	ON
17	ON	OFF	OFF	OFF	ON	OFF	ON	OFF	ON
18	OFF	ON	OFF	OFF	ON	OFF	ON	OFF	ON
19	ON	ON	OFF	OFF	ON	OFF	ON	OFF	ON
20	OFF	OFF	ON	OFF	ON	OFF	ON	OFF	ON
21	ON	OFF	ON	OFF	ON	OFF	ON	OFF	ON
22	OFF	ON	ON	OFF	ON	OFF	ON	OFF	ON
23	ON	ON	ON	OFF	ON	OFF	ON	OFF	ON
24	OFF	OFF	OFF	ON	ON	OFF	ON	OFF	ON
25	ON	OFF	OFF	ON	ON	OFF	ON	OFF	ON
26	OFF	ON	OFF	ON	ON	OFF	ON	OFF	ON
27	ON	ON	OFF	ON	ON	OFF	ON	OFF	ON
28	OFF	OFF	ON	ON	ON	OFF	ON	OFF	ON
29	ON	OFF	ON	ON	ON	OFF	ON	OFF	ON
30	OFF	ON	ON	ON	ON	OFF	ON	OFF	ON

Maximum number of BUS participant = 30 pieces

Maximum number of BUS nodes in relation to the cable length

Wired as a line-shaped: 1 strand

length (m)	number (pc.)
100	20
200	15
300	10
400	10

CM+ — all nodes

Wired as a star-shaped: 2 strands

length (m)		number (pc.)	
A	B	A	B
100	100	15	15
200	200	15	15
300	300	10	10
400	400	10	10

CM+ — nodes group A
nodes group B

Wired as a star-shaped: 3 strands

length (m)			number (pc.)		
A	B	C	A	B	C
100	100	100	10	10	10
200	200	200	10	10	10
300	300	300	10	10	10
400	400	400	10	10	10

CM+ — nodes group A
nodes group B
nodes group C

INSTALLATION STEP 11:

MODIFY MODULE CONFIGURATIONS

The Control Unit is configured at the factory. All specifications in this description refer to standard scope of delivery.

With an optional software for Microsoft® / 10, the configuration can be modified by specially trained and briefed personnel. To accomplish this, a computer (Notebook) must be connected to the Control-Module **CM** via **USB** and an internet connection must be established.

A free version of the system software (**version VIEW**) can be downloaded from the homepage www.aumueller-gmbh.de.



There are two software versions for configuring the system:

- a licensed version
- a freely available version (**version VIEW**)

The **licensed version** offers comprehensive configuration possibilities.



Changes and supplements to the free **version VIEW** are possible at any time without prior notice.



The configuration of the Control Unit using the software has a significant impact on the functionality of the individual system components. Therefore, it might be necessary to connect a computer provided with the system software for precise testing.



To a considerable degree, our Control Unit configuration software prevents damage due to incorrect settings. Nevertheless, we must point out, that the user of the software is exclusively liable for any damages resulting from the use of our software.

Any warranty claims or claims for compensation against the manufacturer of the Control Unit and the software are void unless the system has been configured by the manufacturer if or by a specialist contractor approved by it.

This limitation regarding warranty and product liability also applies to the freely available **version VIEW**. After each configuration, it is therefore advisable to check all functions and take great care in making all settings such as back-up accumulator type, etc.

INSTALLATION STEP 12:

ENABLING OPERATION/COMPLETING INSTALLATION

Before the installer is allowed to enable the operation of the Control Unit, the complete performance range of the system must be checked with utmost care. The chapter „TROUBLESHOOTING AND REPAIR“ provides support for the localisation of possible faults and malfunctions.



Settings, that possibly have to be made with the software via **USB** (connection at Control-Module **CM**), should only be carried out, after the system is otherwise completely installed and connected to the main power supply.

Via **USB** the system configuration can be retrieved with the software of the Control Unit manufacturer and stored or printed out.

After the system is put into operation by switching on the main power supply, all green operation displays of the modules blink for a maximum of 1 minute. The system is now being configured. After configuration, all green operation displays must stay lit up permanently and no yellow fault display be light up.



Constant flashing of the green operational display signals a fault at the Control-Module **CM**. Check **BUS** connection between Power-Module **PM** and Control-Module **CM** as well as the connection of the main power supply to the Power-Module **PM**.

Localize and resolve eventual faults (yellow module displays).

5 A

10 A

24 A

48 A

72 A



Prior to releasing into operation, check all functions of the system carefully.

After each configuration of the module with the software of the Control Unit manufacturer, conduct a thorough check of all system functions.

Set backup accumulators. Backup accumulators must be charged for at least 8 hours to guarantee flawless emergency power operation!

Instruction of the operator in the use of the system is the responsibility of the installer.

After the system operation has been enabled, the operator needs to be instructed by the responsible installer about the operating modes of the Control Unit (e.g. the type of ventilation control). Provided that the factory default configuration has been changed using the system software, all alterations have to be taken into account in the operating manual. There might be a requirement to prepare an operating manual for non-specialist users that is easy to follow and easy to understand.



In case of fire the system saves lives. Therefore immediately remedy or have any fault or malfunction remedied by specialists!

INDICATOR AND CONTROL ELEMENTS

Display the operating state	
Icon	Importance
	Display green: Permanently light: Correct conditions Blinks: Back-up accumulator operation (power failure)
	Display green: Vents are closed.
	Display red: Vents are open.
	Display red: <ul style="list-style-type: none"> On Weather-Module WM: Rain sensor and / or Wind sensor are active.

Displays: Triggering of Alarm / EMERGENCY-OPEN	
Icon	Importance
	Display red: <ul style="list-style-type: none"> On module CM / SM / DM / DMX / IDM: Automatic or manual triggering of EMERGENCY-OPEN
	Display red: <ul style="list-style-type: none"> On Drive-Module DM / IDM (drive line): Smoke and heat vents are polarized in the direction of opening.

Displays of status: Fault	
Icon	Importance
	Display yellow: Fault



EMERGENCY-CLOSE (closing of smoke and heat vents) is possible with the **CLOSE** button in the **break-glass unit**. **Smoke detectors** must be reset with the reset button on the control or Sensor-Module (unless the reset has been configured differently via the software - deviating from the standard).

Overview of the most important displays

Power-Module PM	Power-Module-Extension PME	Control-Module CM	Sensor-Module SM	
Displays: Operation (green) Status (green) Fault (yellow) EMB 8000+ PM	Displays: Operation (green) Status (green) EMB 8000+ PME	Displays: Operation (green) Fault (yellow) Alarm (red) EMB 8000+ Connection: USB SD card Button: Resetting of module	Displays: Operation (green) Fault (yellow) Alarm (red) EMB 8000+ SM Button: Resetting of module	
Displays: Operation (green) Fault (yellow) Alarm (red) EMB 8000+ OPEN (red) CLOSE (green) Buttons: Open Close DM(X)	Displays: Operation (green) Fault (yellow) Alarm (red) EMB 8000+ OPEN (red) CLOSE (green) Buttons: Open Close IDM	Displays: Operation (green) Fault (yellow) EMB 8000+ RM6	Displays: Operation (green) Fault (yellow) EMB 8000+ KNX-programming-LED Button: KNX-programming button IM-K	Displays: Operation (green) Fault (yellow) EMB 8000+ Rain (red) Wind (red) WM

5 A 10 A 24 A 48 A 72 A

LED display for break-glass unit (HSE)		
Display	State	
B <input type="checkbox"/> on S <input type="checkbox"/> out A <input type="checkbox"/> out	Normal operation	
B <input type="checkbox"/> out flashes S <input type="checkbox"/> flashes A <input type="checkbox"/>	Fault (back-up accumulators mode)	
B <input type="checkbox"/> blinks quickly S <input type="checkbox"/> blinks quickly A <input type="checkbox"/>	Fault at EMERGENCY-CLOSE line	
B <input type="checkbox"/> blinks quickly S <input type="checkbox"/> blinks quickly A <input type="checkbox"/>	Fault smoke detector line 2	
B <input type="checkbox"/> blinks slowly S <input type="checkbox"/> blinks slowly A <input type="checkbox"/>	Fault smoke detector line 1	
B <input type="checkbox"/> on S <input type="checkbox"/> on A <input type="checkbox"/> blinks slowly	Smoke detector still active after EMERGENCY-CLOSE	
B <input type="checkbox"/> on S <input type="checkbox"/> on A <input type="checkbox"/> on	Fault to break-glass unit lines	
B <input type="checkbox"/> blinks quickly S <input type="checkbox"/> blinks quickly A <input type="checkbox"/> blinks quickly	Break-glass unit lines still triggered after EMERGENCY-CLOSE	
B <input type="checkbox"/> on S <input type="checkbox"/> on A <input type="checkbox"/> on	Alarm- or EMERGENCY-OPEN state	

B <input type="checkbox"/> Operation	green (GN)
S <input type="checkbox"/> Fault	yellow (YE)
A <input type="checkbox"/> EMERGENCY-OPEN LED display	red (RD)



The functionalities of the external LED outputs are configurable.

FUSE

The fuse is located on top of the respective module. The following modules are secured with fuses:

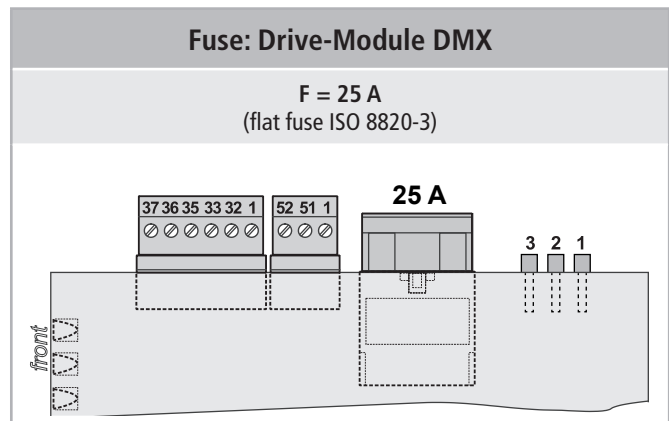
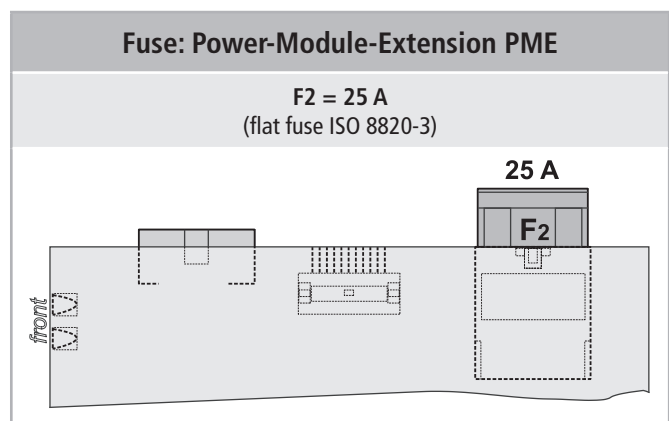
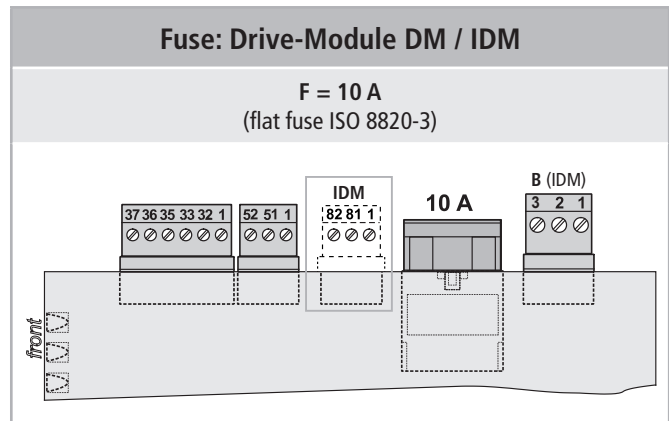
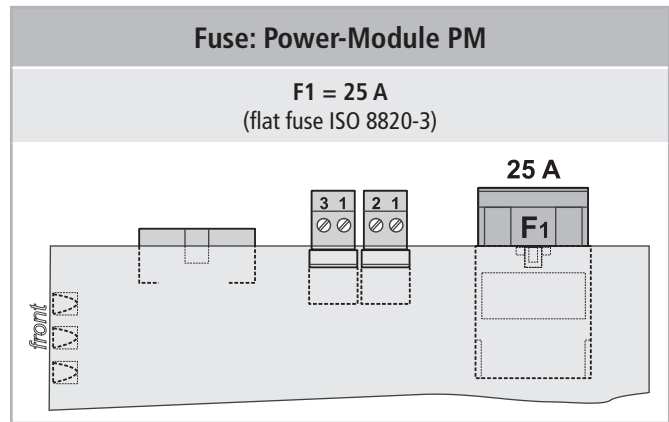

TROUBLESHOOTING AND REPAIR

All functions and system components that are important for the RWA operation are constantly monitored for faults. A fault indication signals the type of fault or possible errors when connecting system components (such as back-up accumulators, detectors, drives) during commissioning of the Control Unit.

The overview below details some of the possible faults and problem cases and their causes. You will find a list of all indicators in chapter „INDICATOR AND CONTROL ELEMENTS“.

Power-Module PM		
Back-up accumulator operation (power failure)		Cause / possible solution
	green no signal	
	green	Check the mains voltage
Fault		Cause / possible solution
	green no signal	Power failure or power supply too low (<20 V)
	green	Communication fault BUS connection
	green no signal	no power supply
	yellow	Power-Module PM fuse or charging switch defective
<small>Reacts with a delay of approx. 30 seconds.</small>		
	yellow	No back-up accumulator connection or defective fuse at Power-Module-Extension PME
<small>Reacts with a delay of approx. 30 seconds.</small>		
	yellow	System voltage is switched off due to overload
<small>Reacts with a delay of approx. 30 seconds.</small>		

Power-Module-Extension PME		
Back-up accumulator operation (power failure)		Cause / possible solution
	green no signal	
	green no signal	
Fault		Cause / possible solution
	yellow Display from PM!	Fuse defective at the PME
<small>Reacts with a delay of approx. 30 seconds.</small>		

Control-Module CM		
Triggering of alarm (EMERGENCY-OPEN)		Cause / possible solution
	red	triggered EMERGENCY-OPEN
<small>Displays also valid for external LEDs (break-glass unit)</small>		
	red	Smoke detector still active after EMERGENCY-CLOSE
<small>Displays also valid for external LEDs (break-glass unit)</small>		
	red	Manual alarm still on after EMERGENCY-CLOSE
<small>Displays also valid for external LEDs (break-glass unit)</small>		
Fault		Cause / possible solution
	green no signal	
	yellow	Fault signalling line 1 (automatic detector or ext. fire alarm)
	yellow	Fault signalling line 2 (automatic detector or ext. fire alarm)
	yellow	Fault signalling line 3 (automatic detector or ext. fire alarm)
	yellow	Back-up accumulator fault
	yellow	System in back-up accumulator operation
Maintenance information		Cause / possible solution
	yellow	System maintenance required
<small>Displays also valid for all connected break-glass units of control-Module CM</small>		
CAN-BUS fault		Cause / possible solution
	green	and
	yellow	Number of modules in system doesn't coincide with system configuration (display also indicates change of original system configuration)
	yellow	CAN participant is (still) missing or system with CAN BUS is currently being configured
<small>Displays also valid for external LEDs (break-glass unit)</small>		

5 A 10 A 24 A 48 A 72 A

Sensor-Module SM		
Triggering of alarm (EMERGENCY-OPEN)		Cause / possible solution
red		EMERGENCY-OPEN has triggered <small>Displays also valid for external LEDs (break-glass unit)</small>
red		Smoke detector still active after EMERGENCY-CLOSE <small>Displays also valid for external LEDs (break-glass unit)</small>
red		Manual alarm still on after EMERGENCY-CLOSE <small>Displays also valid for external LEDs (break-glass unit)</small>
Fault		Cause / possible solution
yellow no signal		and
yellow		Fault signalling line 1 (automatic detector or ext. fire alarm)
yellow		Fault signalling line 2 (automatic detector or ext. fire alarm)
yellow		Fault signalling line 3 (automatic detector or ext. fire alarm)
yellow		System in back-up accumulator operation
green		No correct BUS connection (☞ check ribbon cable) or Fault at Control-Module CM (☞ check power supply)

Drive-Module DM (10A) / DMX (20A) / IDM (10A)		
Triggering of alarm (EMERGENCY-OPEN)		Cause / possible solution
red		Open smoke vents (drives)
red		Open smoke vents open at back-up accumulator operation (230V-Drive-Modul Vent: Modul at back-up accumulator operation) <small>Displays also valid for external LEDs (break-glass unit)</small>
Fault		Cause / possible solution
green		No correct BUS connection (☞ check ribbon cable) or Fault at Control-Module CM (☞ check power supply)
green no signal		and
yellow		Fuse defective (DM = 10A / DMX = 20A / IDM = 10A) (☞ check and replace if need be) or Short circuit or line interruption at drive line (☞ check the line end module) or Fault in power supply of module

Fault: IM-K KNX-Modul		
Fault		Cause / possible solution
green		No correct BUS connection (☞ check ribbon cable)
green no signal		and
yellow		Fuse defective (☞ check and replace if need be) or Short circuit or line break at drive line (☞ check the line end module) or Fault in power supply of module

Weather-Modul WM		
Fault		Cause / possible solution
green no signal		and
yellow		Fault from wind direction finder if applicable
green		BUS communications connection fault (at Control-Module CM)

07

MAINTENANCE AND MODIFICATION

To ensure continuous function and safety of the complete system periodic maintenance by a specialist contractor is required at least once a year (as mandated by law for smoke and heat exhaust systems). Operational readiness must be checked regularly, at least once a month.



After opening the system housing, live parts are exposed! Each time, before performing maintenance work or modifying the structure (e.g. replacement of the window drive), the mains voltage and – as far as available – the accumulators must be completely disconnected and secured against unintentional reactivation (lock in isolation mode).

The information provided in these instructions for maintenance must be observed. Malfunctions must be remedied immediately. Only spare parts made by the manufacturer may be used. Between maintenance intervals the operator must carry out or order a visual inspection at least once and document it in writing in the log book. We recommend a maintenance contract with a specialist contractor authorised by the manufacturer. A sample maintenance contract can be downloaded from the homepage of

AUMÜLLER AUMATIC GMBH
(www.aumueller-gmbh.de).

What has to be serviced?

- Check all **connections** (those in the Control Unit) for tightness and for possible damage.
- Check all **fuse links**.
- Check charge level and installation date of back-up **accumulators** and exchange the accumulators, if necessary (accumulators must be exchanged 4 years after installation). Note the exchange date on the accumulator. Dispose of removed accumulators in compliance with legal requirements.
- Check **drive control** for proper function. Also check drive run directions. If the actuation is correct but the drive is still not working properly, consult the assembly and maintenance instructions of the drive manufacturer.
- Check all **break-glass units** and ventilation buttons for serviceability (do the drives move in the direction indicated on the buttons?)
- Check all **smoke detectors** according to manufacturer's instructions using test gas.
- Remove dirty or faulty **detectors** and send them to the manufacturer for repair or cleaning.
- When connecting **wind and rain sensors**, check that the sensors are serviceable - and readjust the wind response threshold, if necessary.
- Check the **configuration** with our system software and test if the system works with the stored configuration.

The service instructions for the connected components are decisive for their maintenance.

IMPORTANT MAINTENANCE INFORMATION

- While working in the Control Unit the workplace must be secured against unauthorised access.
- The specialists performing the maintenance work are solely responsible for maintenance.
- For smoke and heat exhaust systems a log book must be kept in which the maintenance work must be documented. Special attention must be paid to operating events (e.g. repeatedly occurring malfunctions) which may be recorded.
- These installation and operating instructions are part of the maintenance documents. The control device may be maintained only by considering the information provided therein. This affects also system supplements and the exchange of components. A separate maintenance protocol should be prepared and filed with the maintenance documents.
- Only original parts may be used. Otherwise the warranty obligation and product liability of the manufacturer shall no longer apply.
- For the maintenance of individual system components the installation and maintenance instructions of the manufacturer of these components must be binding. If they are not available, they must be requested from the manufacturer. In case special maintenance instructions are prescribed (e.g. for natural smoke and heat exhaust ventilators pursuant to EN 12101-2), they must also be on hand.



The system configuration must be checked and recorded with each service

DEMOUNTING AND DISMANTLING

The Control Unit must be stored only in locations protected from moisture, severe contamination and temperature fluctuations (not above 30°C). The packaging must not be removed until the control system is to be installed. Disconnect the accumulators and store them separately after the control device has already been in operation.

It is imperative that the following is observed for storage of the accumulators:



Keep the storage time of lead-acid accumulators short, because the accumulators discharge as time passes. At the latest after seven months in storage accumulators must be recharged. Use either a suitable accumulator charger or connect the accumulators to an EMB Control Unit and supply same with mains voltage. In both cases, charging requires a minimum of 8 hours (depending on the discharge state).

If the Control Unit is permanently decommissioned the statutory provisions for destruction, recycling and disposal must be observed. The control device contains plastic, metal, electrical components and accumulators. Replaced accumulators contain highly toxic pollutants and may therefore only be disposed of at collection points prescribed by the legislator.



Before dismantling the Control Unit, isolate it completely from the mains!

DISPOSAL

According to the European Directive 2012/19 / EU on Waste Electrical and Electronic Equipment (WEEE) and its transposition into national law, obsolete electrical appliances must be collected separately and sent for environmentally friendly recycling.



WARRANTY AND CUSTOMER SERVICE

In principle, our:

„General Terms for the Supply of Products and Services of the Electrical Industry (ZVEI)“.

„Terms for the used software“.

The warranty is compliant with legal provisions and applies to the country in which the product has been acquired.

The warranty includes material and manufacturing defects incurred during normal use.

The warranty period for delivered material is twelve months.

Warranty and liability claims for personal injuries or tangible damages are excluded, if caused by one or more of the following:

- Improper use of the product.
- Improper installation, commissioning, operation, maintenance or repair of the product.
- Operating the product, if installed defectively or incorrectly, or with its safety and protection devices not working .
- Ignoring instructions and installation requirements in these instructions.
- Unauthorised constructional modifications the product or accessories.
- Disaster situations due to the effects of foreign bodies and force majeure.
- Wear and tear.

Point of contact for possible warranty claims or for repair parts or accessories is the responsible branch office or the responsible person at

AUMÜLLER AUMATIC GMBH.

Contact data are available at our homepage

(www.aumueller-gmbh.de)

LIABILITY

We reserve the right to change or discontinue products at any time without prior notice. Illustrations are subject to change. Although we take every care to ensure accuracy, we cannot accept liability for the content of this document.



**CERTIFICATE AND
DECLARATION OF CONFORMITY**

We declare under our sole responsibility that the product described under "Data sheet" is in conformity with the following directives:

- 2014/30/EU
Directive relating to Electro-Magnetic Compatibility
- 2014/35/EU
Low voltage Directive



Technical file and declaration at firm:

AUMÜLLER AUMATIC GmbH
Gemeindewald 11
D-86672 Thierhaupten

Ramona Meinzer
Managing Director (Chairman)

NOTE:

The proof of the application of a quality management system is for company:

AUMÜLLER AUMATIC GmbH
according to the certification basis **DIN EN 9001** as well the "Declaration of Incorporation and Conformity" can be accessed via the QR code or directly on our homepage: (www.aumueller-gmbh.de)



THIS IS A TRANSLATION OF THE ORIGINAL DOCUMENTATION IN GERMAN (GERMANY)

Important note:

We are aware of our responsibility, which is why we present life-supporting and value-preserving products with greatest possible conscientiousness. Although we make every effort to ensure that the data and information are as correct and up-to-date as possible, we still cannot guarantee that they are free from mistakes and errors.

All information and data contained in this document are subject to alterations without prior notice. Distribution and reproduction of this document as well as the use and disclosure of its content is not authorised unless expressly approved. Offenders will be held liable for the payment of damages. All rights reserved in the case of a patent award or utility model registration.

Basically the General Terms and Conditions of **AUMÜLLER AUTOMATIC GmbH** apply to all offers, supplies and services.

The publication of these assembly and commissioning instructions supersedes all previous editions.

AUMÜLLER Aumatic GmbH
Gemeindewald 11
86672 Thierhaupten

Tel. +49 8271 8185-0
Fax +49 8271 8185-250
info@aumueller-gmbh.de

www.aumueller-gmbh.de

9000024701_V1.3_KW43/21